

---

**SURATLAR  
PLATES  
ИЛЛЮСТРАЦИИ**

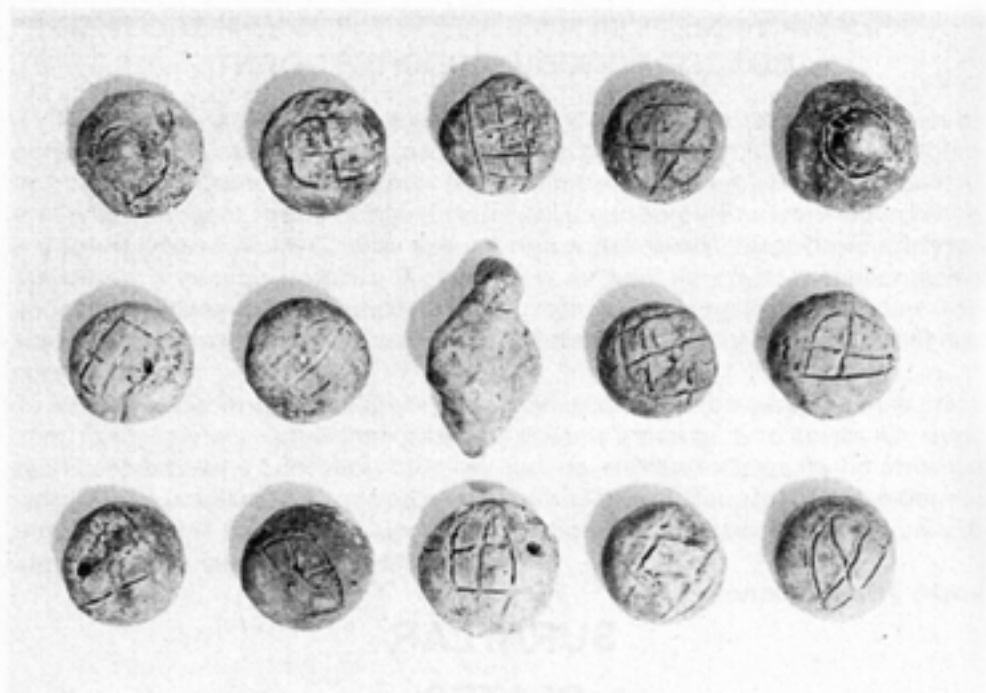

1. Tokinler — çyzyklar, belgiler edilen toýun göjekler

Fig.1. Tokens — earthenware balls with scratched signs from Gonur palace

Илл.1. Токины — глиняные шарики с нацарапанными знаками из гонурского дворца



2. Goňurdan tapylan myh ýazgysy bolan

Fig.2. Cylindrical seal with cuneiform from Gonur-depe and its impression.

Илл.2. Цилиндрическая печать с клинописью из Гонур-депе и ее оттиск



3. Goňurdan tapylan Harappa möhüri. Asyl nusgasy we onuň basgysy

Fig.3. Harappian seal from Gonur-depe  
Илл.3. Хараллская печать из Гонур-депе

№ 3340

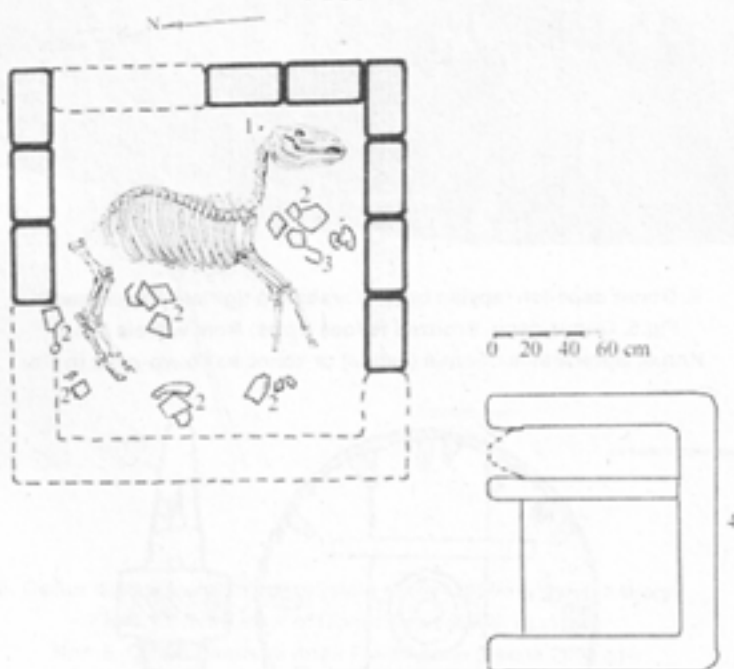

4. Demırgazyk Goňuryň guburhanasyndaky (N 3340) taýçanagyň jaýlanan ýeriniň plany  
Fig.4. Plan of the stallion burial (# 3340) at the royal necropolis of the North Gonur  
Илл.4. План погребения жеребенка (№ 3340) на царском некрополе Северного Гонура



5. Gonur depeden tapylan burunç arabanyň tigrleriniň gurşawlary  
 Fig.5. Gonur-depe. Bronzed felloes (tyres) from wheels in situ  
 Илл.5. Бронзовые ободья (шины) от колес из Гонур-депе in situ

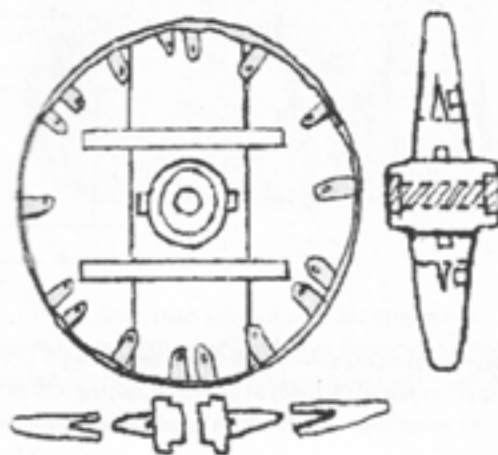

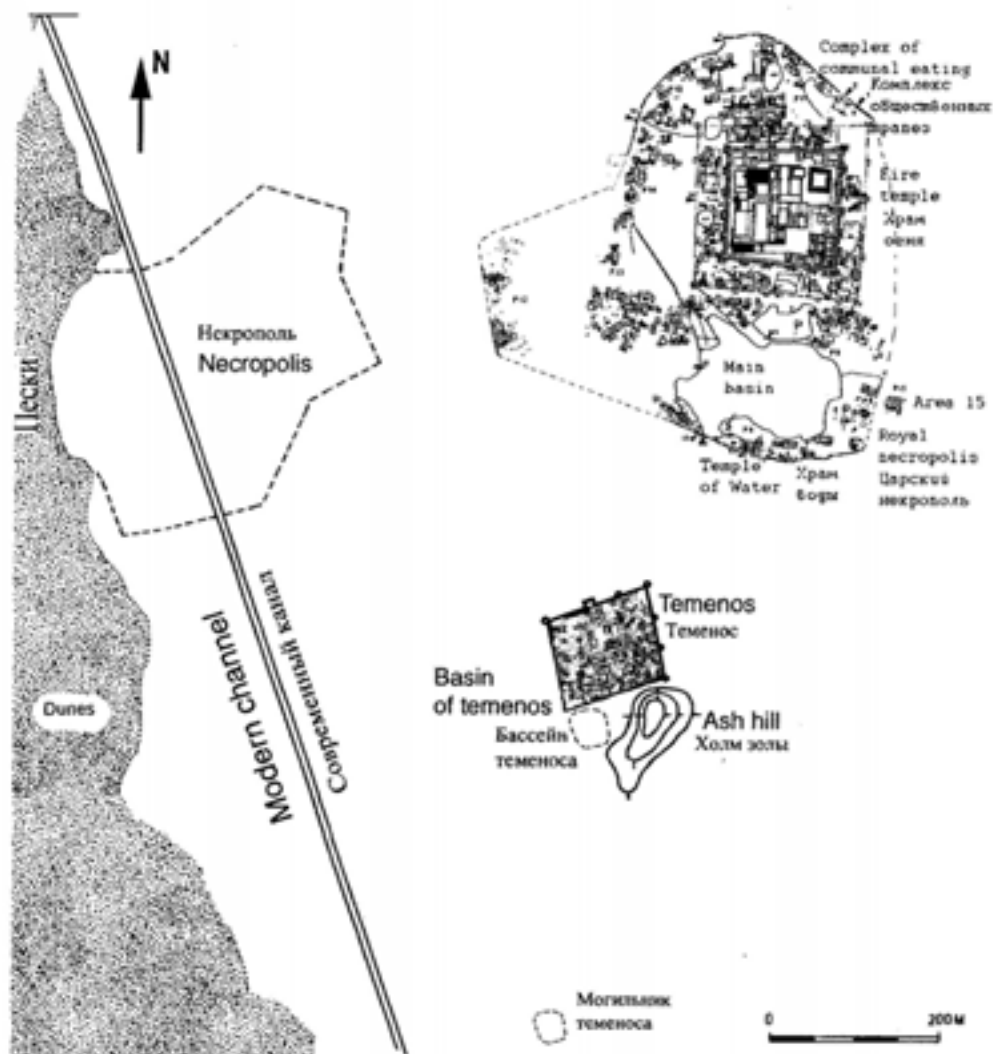

6. Goňur depäniň umumy görnüşiniň plany (2006-njy ýylyň bahary)

Fig.6. General view of Gonur Depe (2006, spring)

Илл.6. Ситуационный план Гонур-депе (весна 2006 г.)



7. Goňurdaky köşk - ybadathana toplumynyň umumy görnüşiniň plany (2006-njy ýulyň bahary)

Fig.7. Plan of the central part of the Palace-temples complex of the North Gonur (2006, spring).  
Squares of communal eating are shaded

Илл.7. Общий план центральной части дворцово-храмового комплекса Северного Гонура  
(весна 2006 г.). Штриховкой выделены площади общественных трапез

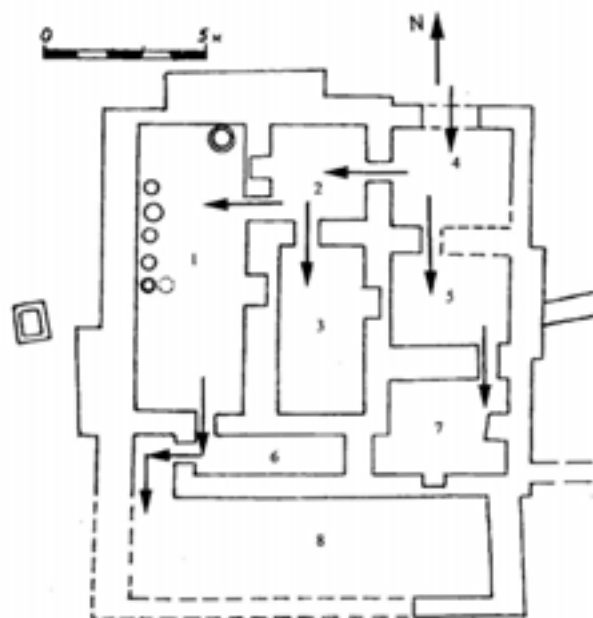

8. Margiananyň düzümindäki iň gadymy soma-haoma köşgüniň plany  
(Demirgazyk Goňurdaky 15-nji gazuw meýdany)

Fig.8. Plan of the earliest in Margiana Soma-Khaoma Temple (Area 15 of North Gonur)

Илл.8. План самого раннего в системе всей Маргианы храма сомы-хаомы  
(Раскоп 15 Северного Гонура)



9. Goňurdaky temenosyň (mukaddes meýdanyň) çäginäki köşgüň plany

Fig.9. Temenos of Gonur. Plan of the temple

Илл.9. План храма на территории теменоса Гонура



10. Togalak-1 ybadathanasyndan tapylan dini dessur ähenli gap  
 Fig.10. Togolok 1 temple. Vessel with modelled frieze on rim  
 Илл.10. Сосуд из храма Тоголок 1 с наlepным фризом на венчике

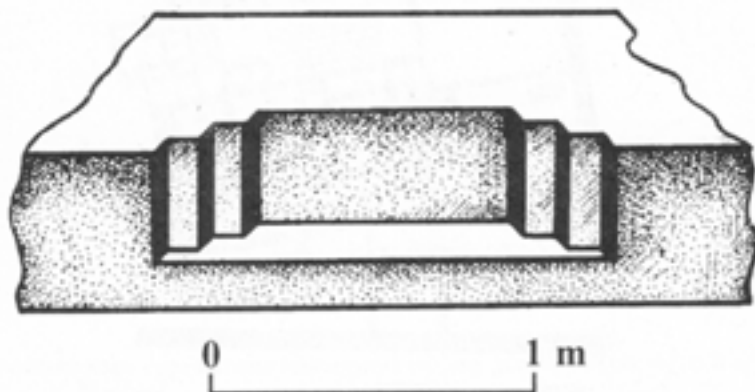

11. Goňurdaky umaratlaryň birindäki basganjakly tagçanyň görnüşü  
 Fig.11. Gonur palace. "Blind windows" in one of halls  
 Илл.11. "Слепые окна" в одном из помещений дворца Гонура



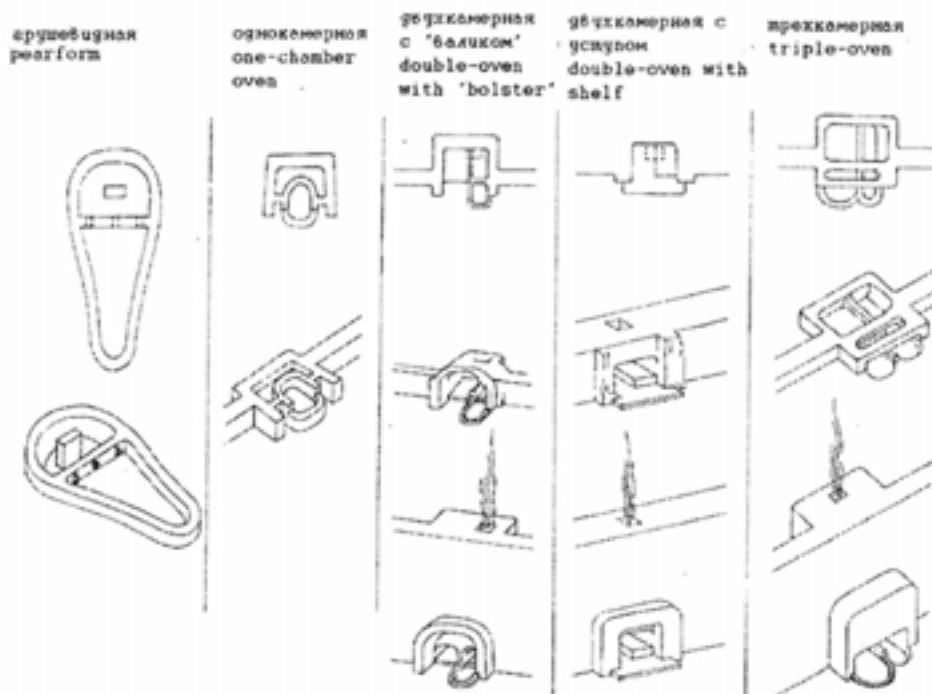

12. Demirgazyk Goňurdaky dini dâp-dessur äheňli ögjaklaryň görnüşleri  
 Fig.12. Types of cult ovens of North Gonur  
 Илл.12. Типы культовых печей Северного Гонура



13. R.Garneriň kolleksiyasynda saklaýan Baktriýanyň bürünç möhürindäki şekil  
 Fig.13. Drawing of the image on the bronze seal from Bactria (R. Garner's collection)  
 Илл.13. Прорисовка изображения на бронзовой печати из Бактрии, хранящаяся в коллекции Р. Гарнера

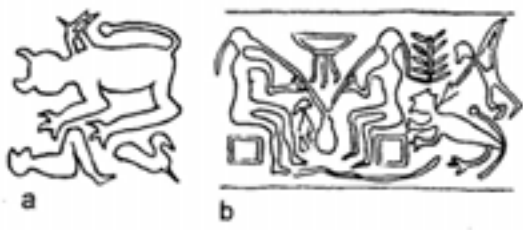

14. Togolak-21 ybadathanasyndan tapylan tumaryň ýüzündäki meňzeş şekiller (a) we siro-hett silindrden şekiller  
 Fig.14. Images on the amulet from Togolak-21 (a) and Siro-Hittite cylinder (b)  
 Илл.14. Сходные изображения на амулете из храма Тоголок-21 (а) и сиро-хеттском цилиндре (б)



15. Karasaspanyň (?) şekilleri. a) Goňurdaky guburhana, N 2790. b) Goňurdaky guburhana N 1200. c) Margiana, Togolok oazisi. d-i) Baktriýanyň guburhanalaryndan

Fig.15. Kersaspa's(?) images. a) Gonur necropolis, burial № 2790; b) Gonur necropolis, burial № 1200; c) Margiana, Togolok oasis; d-i) from the plundered tombs of Bactria

Илл.15. Изображения Керсасы (?): а) некрополь Гонура, погребение № 2790. б) некрополь Гонура, погребение № 1200; в) Маргиана, Тоголокский оазис; г-и) из некрополей Бактрии



16. Togolok-21 ybadathanasyndan tapylan mermerden ýasylan ölüziň kellesi  
Fig.16. Marbled bull's head from the Togolok 21 temple  
Илл.16. Мраморная голова быка из храма Тоголок 21



17. Goňurdepedäki guburlaryň görnüşleri.  
a) "Dahma" — Demirgazyk Goňurdaky köşgüň çägindeki 92-nji otag  
Илл.17. Типы погребений Гонур Деле: а) "Дахма" — пом. 92 Дворца Северного Гонура



b,c) Goňurdaky guburhana (N 412). Böklekleyin giburlar  
b,c) Фракционное погребение (№ 412) некрополя Гонура



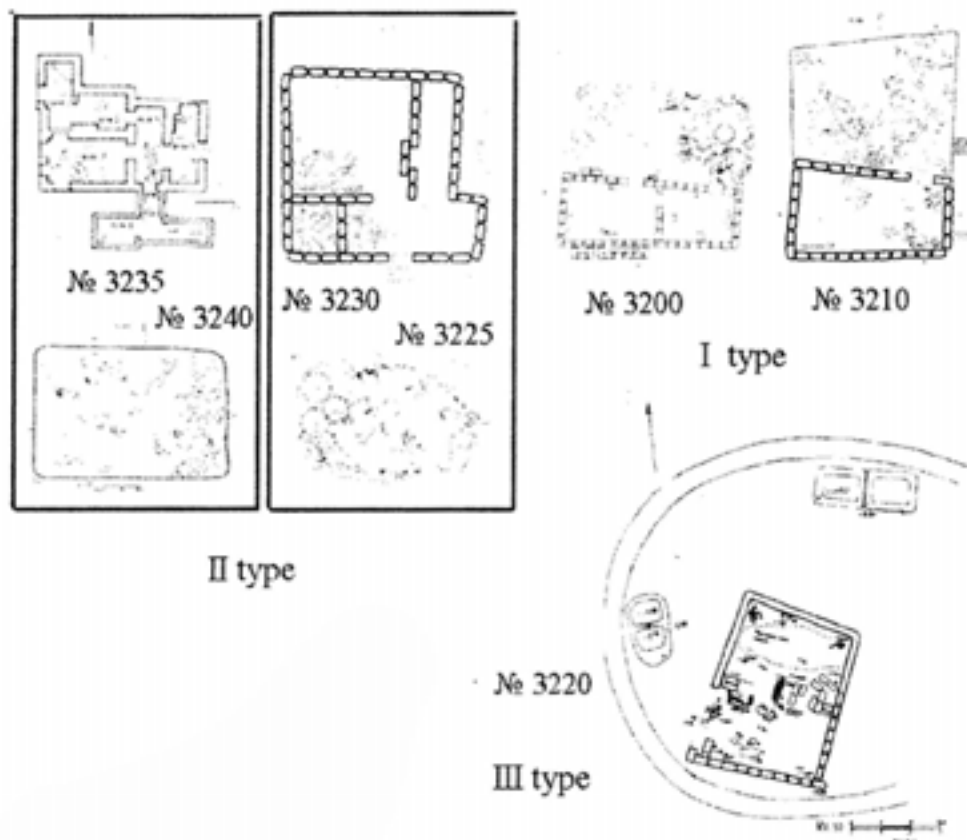

d) Demirgazyk Gohurdaky patyşalaryň guburhanasy  
d) Царские гробницы Северного Гонура

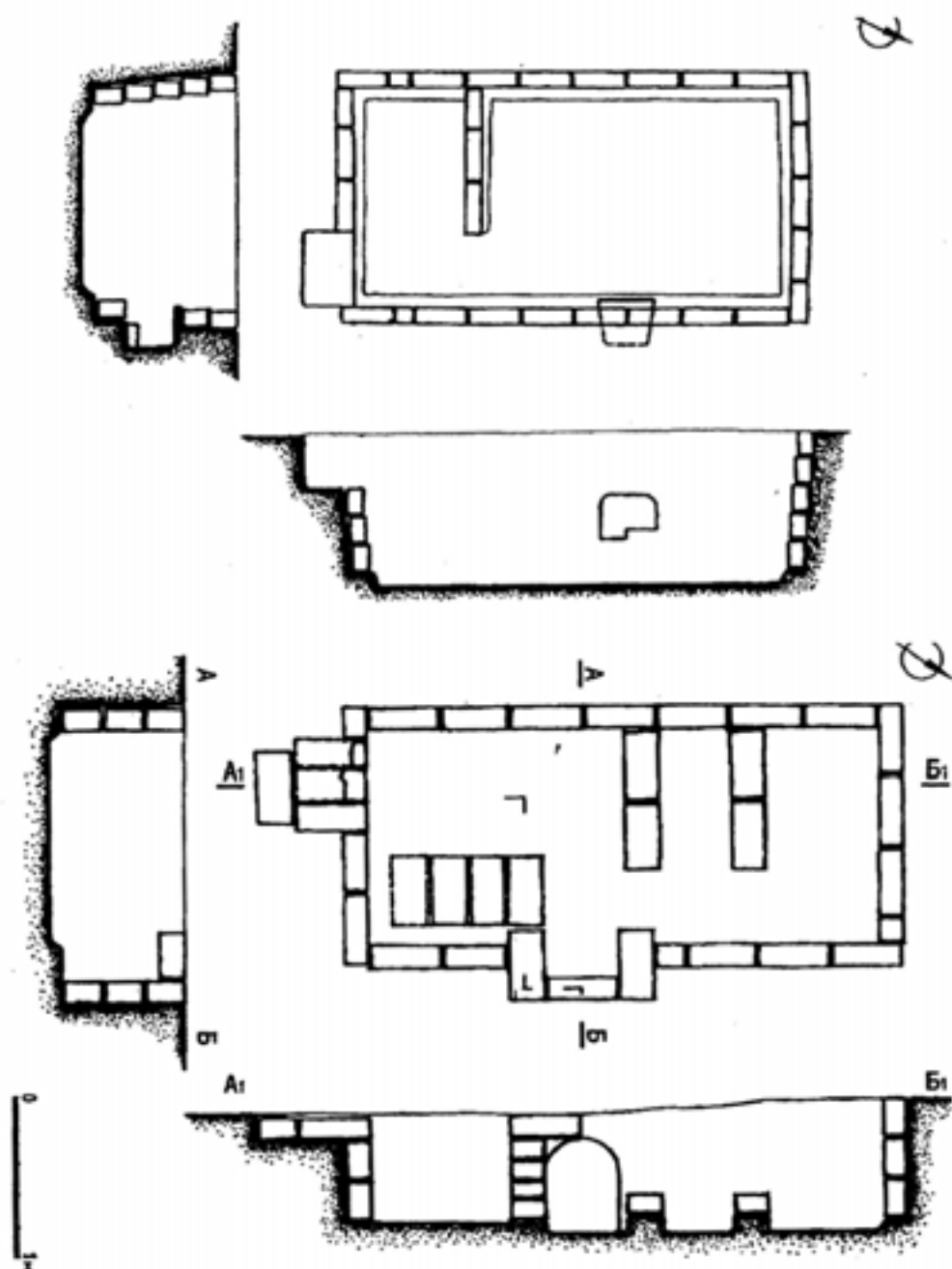

е) Guburhanadaky аўгу-аўгу mazarlar (1- № 555; 2 — № 585; 3 — № 1750)  
 е) Камерные гробницы некрополя (1- № 555; 2 — № 585; 3 — № 1750)

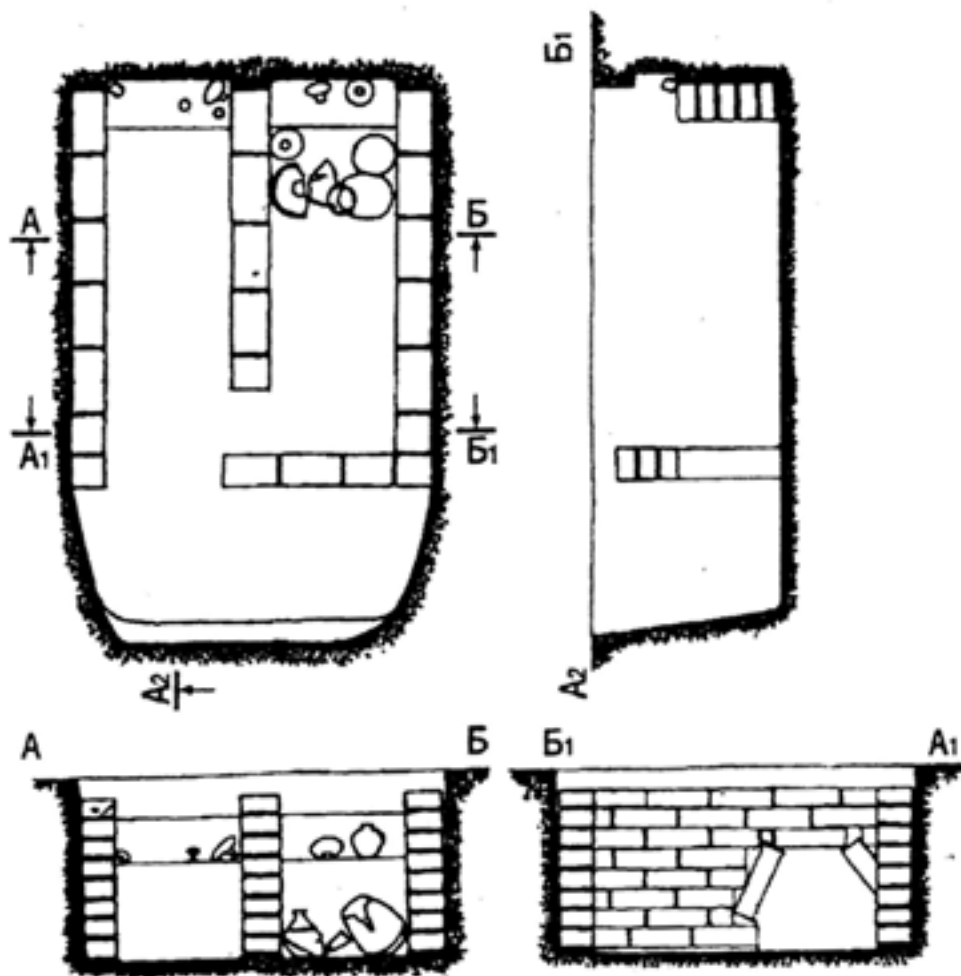

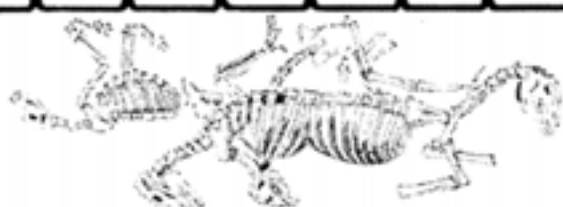
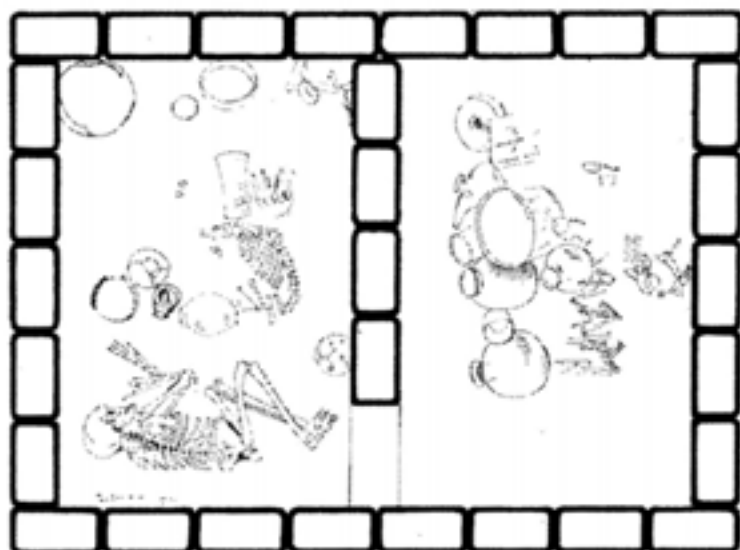

# 3310

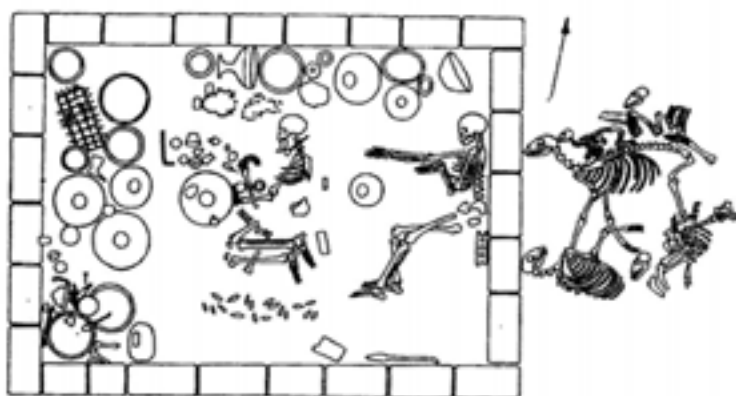

#2900

f) Demigazyk Goňur. Guburhananyň daşyňyň çig kerpiçden örümleri  
 f) Цисты из сырцовых кирпичей Северного Гонура (1 — № 3310; 2 — № 2900)



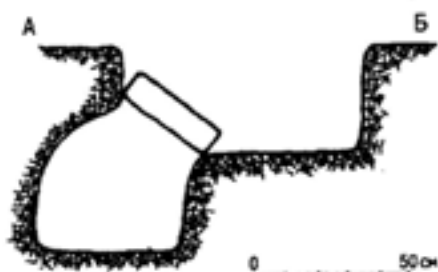
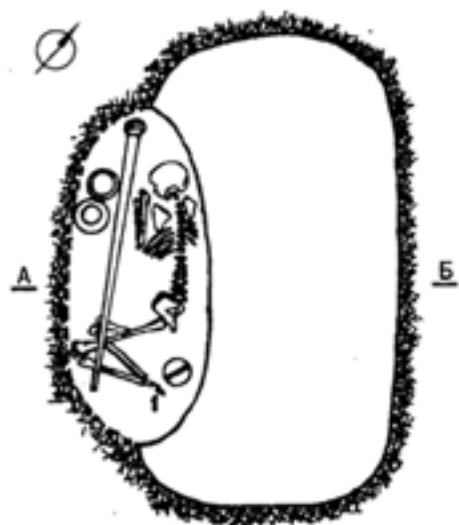

g) Dikligine gazylan mazar. Goňur guburhanasy N 1500  
 g) Подбойное (шахтное) захоронение № 1500 некрополя Гонура



h) Çukur görnüşde uzynlygyna gazylan mazar. Goňur guburhanasy N 1389  
 h) Ямное погребение № 1389 некрополя Гонура

18. Demirgazyk Goňur. N 2999 guburdan tapylan çaga kelleçanany boýunça gaýtadan dikeldilen grafiki şekil. T.S.Baluýewanyň işi

Илл.18. Графическая реконструкция облика ребенка по черепу из погр. 2999 Северного Гонура. Работа Т.С. Балуевой





19. Kelleçanaklar boyunca adamların daşky keşbiniň rekonstruksiyasy.  
a) N 3343; b) N 3243

Илл.19. Графические реконструкции внешнего облика по черепам:  
а) № 3343 и б) № 3243  
(выполнены А.И. Нечвалодой)

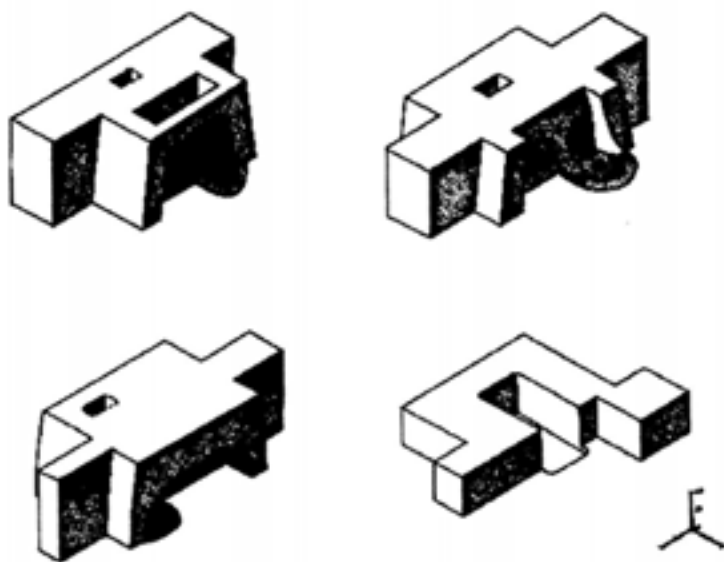

20.  
Fig.20.  
Mnn.20.

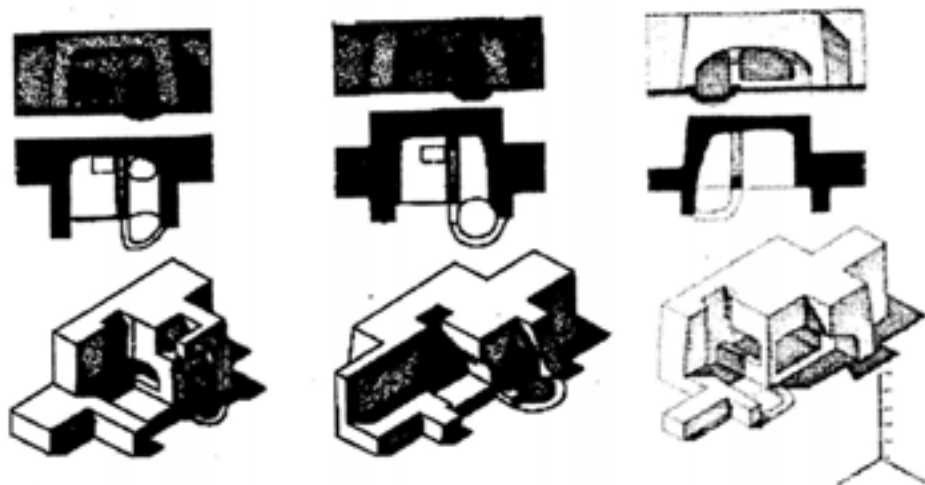

21.  
Fig.21.  
Mnn.21.

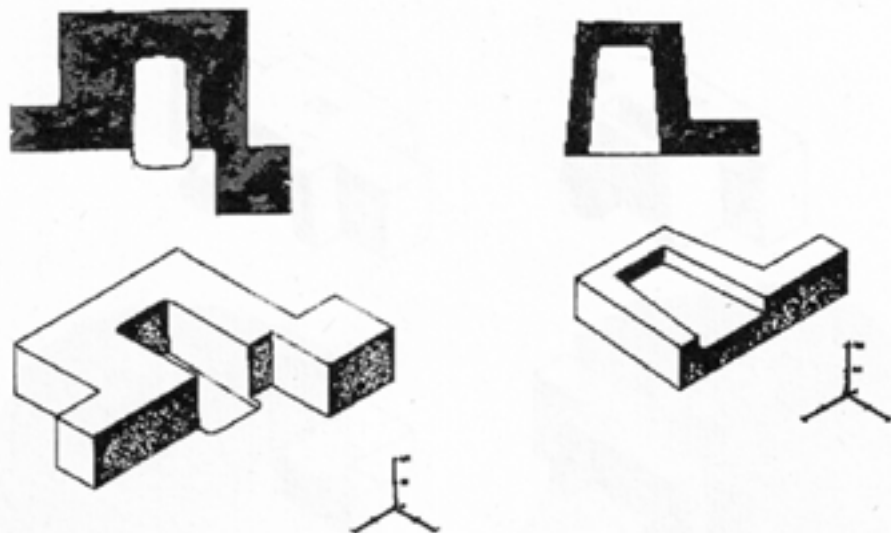

22.  
Fig.22.  
Mnn.22.



23.  
Fig.23.  
Mnn.23.

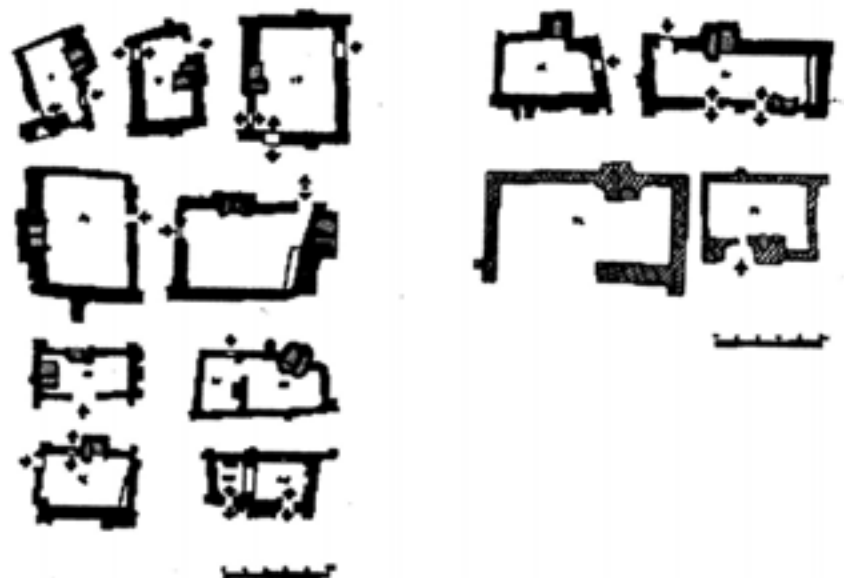

24.  
Fig.24.  
Mnn.24.

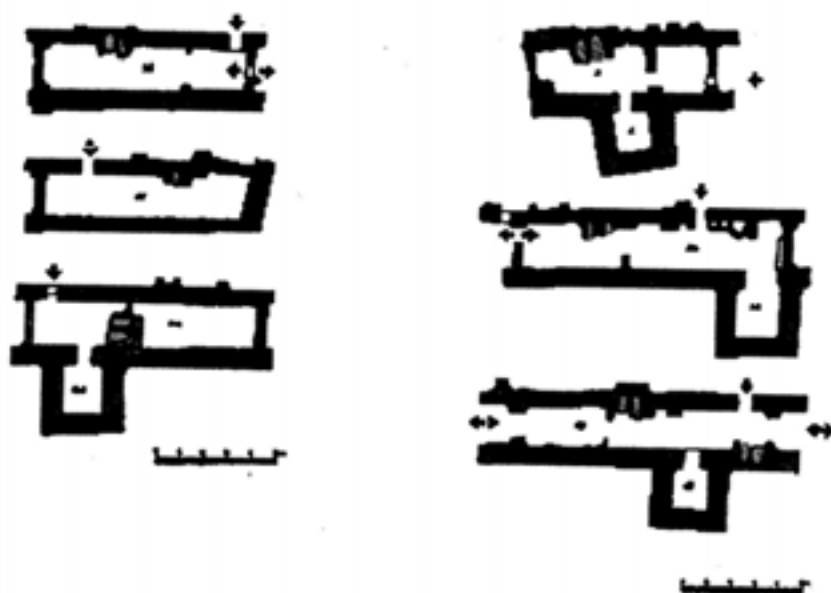

25.  
Fig.25.  
Mnn.25.

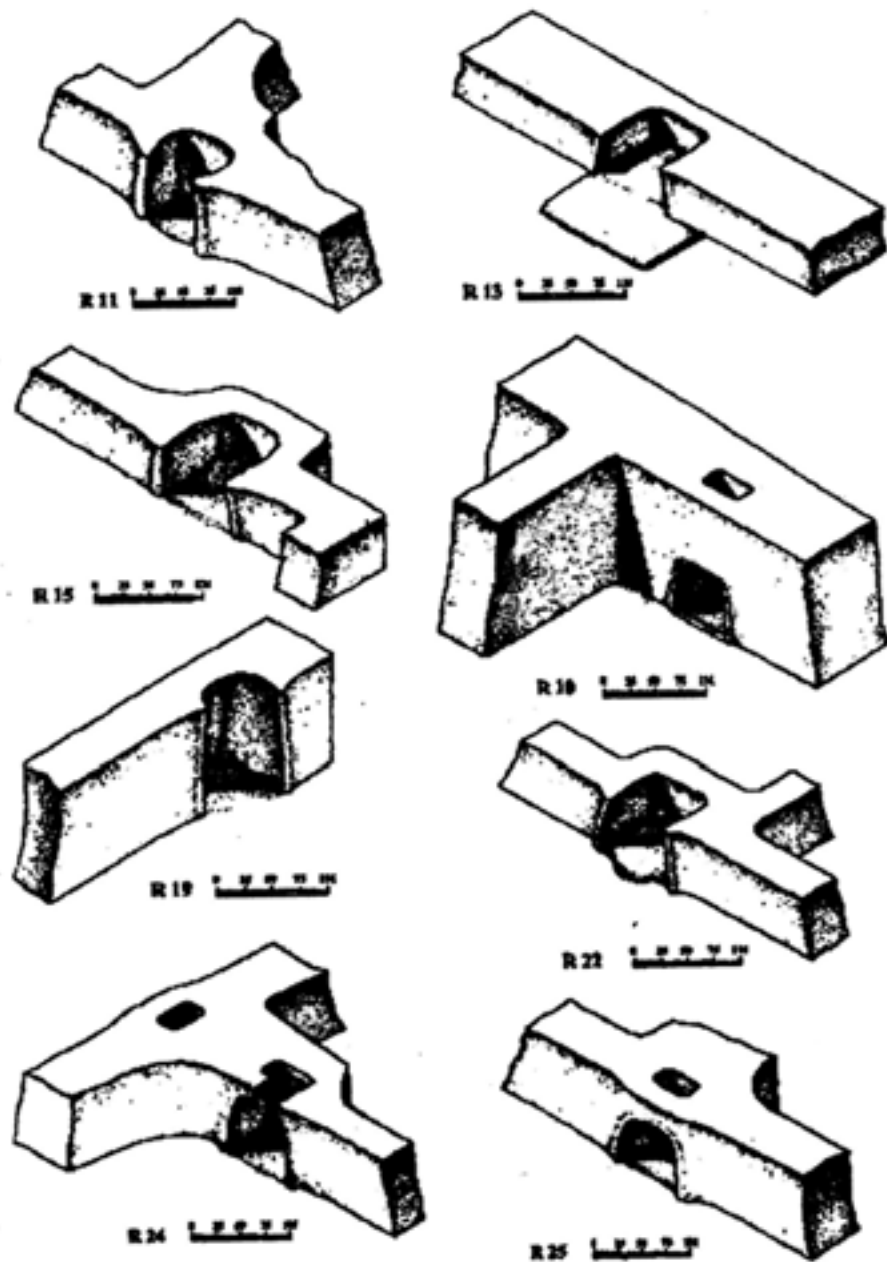

26.  
 Fig.26.  
 Mnn.26.



27.  
Fig.27.  
Wnn.27.

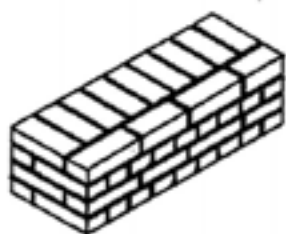
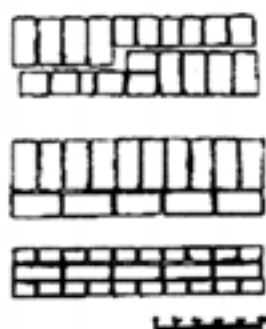
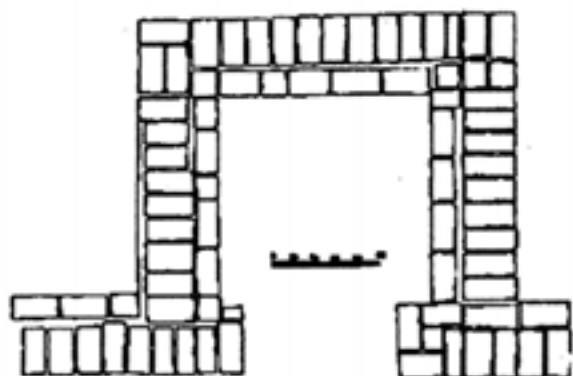

28.  
Fig.28.  
Mnn.28.

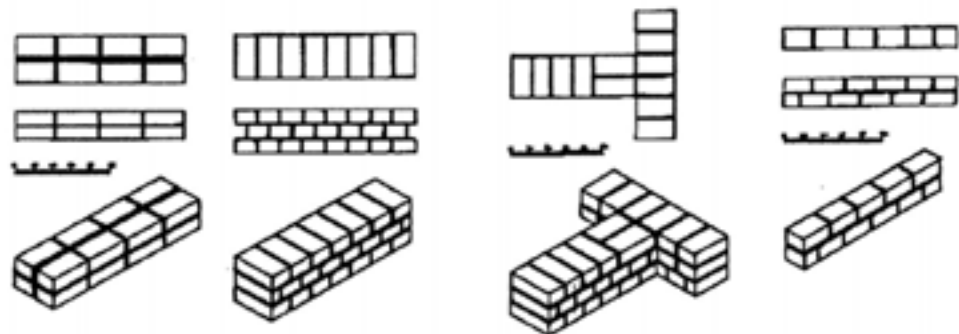

29.  
Fig.29.  
Mnn.29.





30.  
Fig.30.  
Mnn.30.

|                |  |
|----------------|--|
| Damb Sadaat II |  |
| Namazga III    |  |
| Damb Sadaat II |  |
| Namazga III    |  |

31.  
Fig.31.  
Mnn.31.

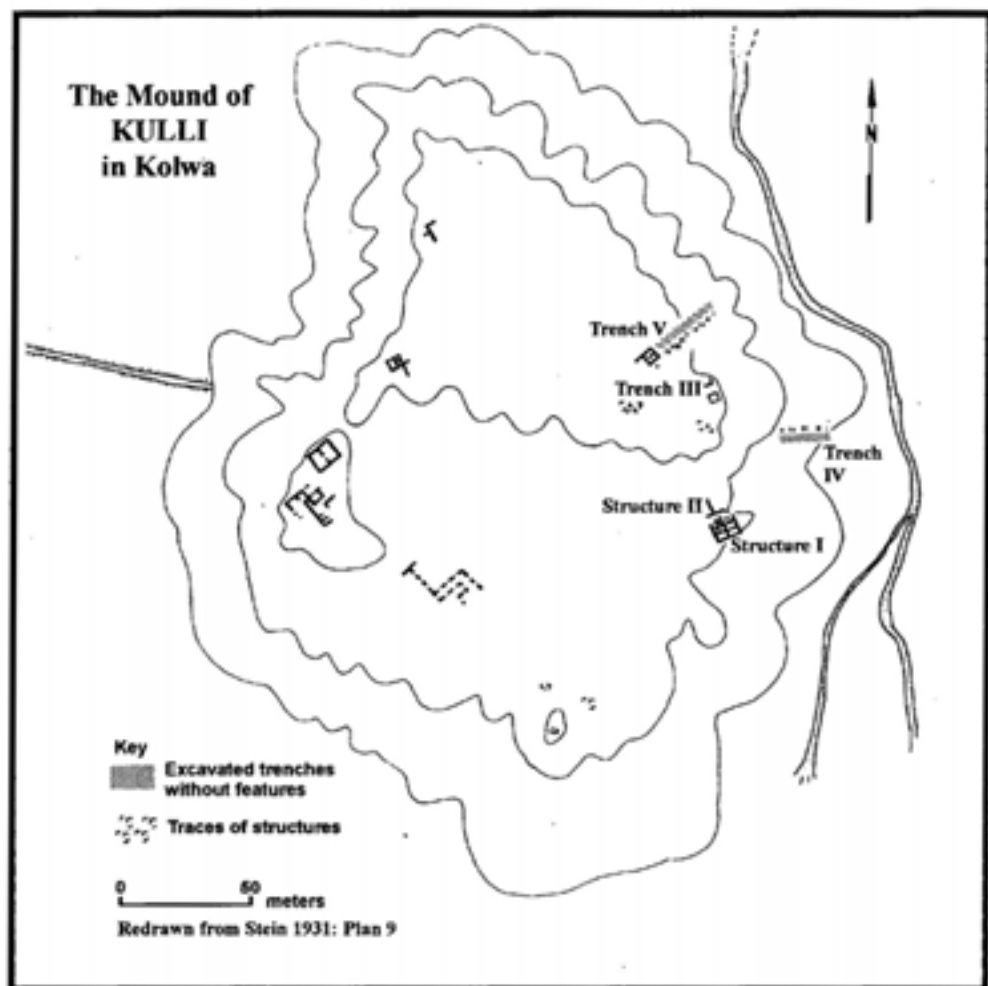

32.  
Fig.32.  
Mun.32.

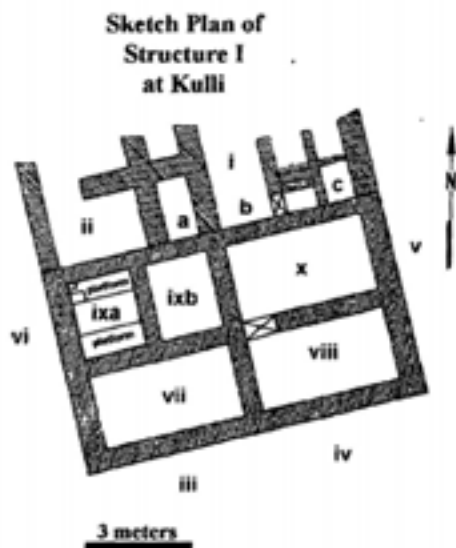

**Sketch of elevation  
showing masonry on  
wall face v, Structure I  
at Kulli**

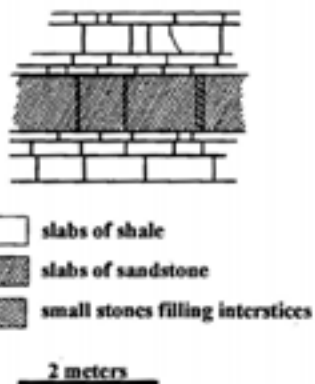

33.  
Fig.33.  
Mnn.33.



34.  
Fig.34.  
Mnn.34.

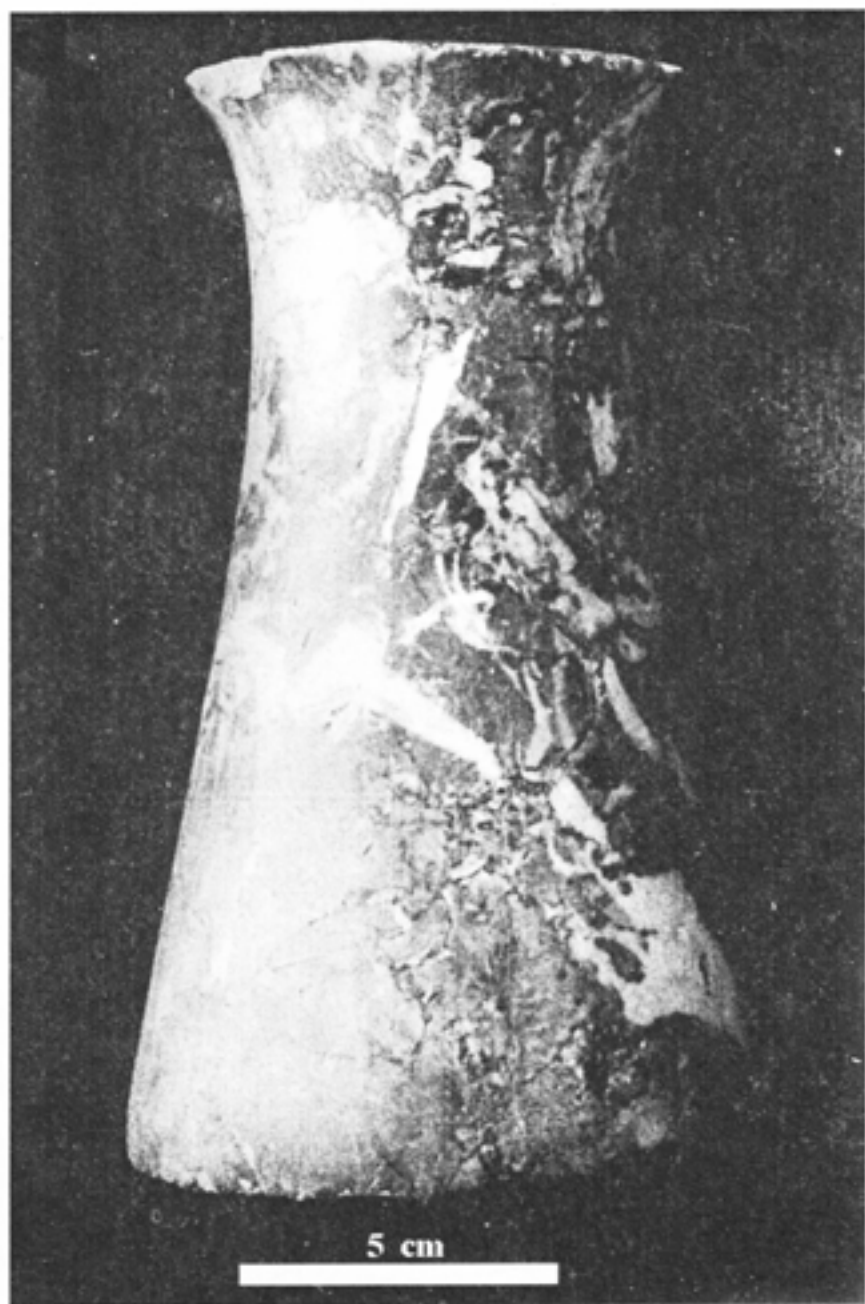

35.  
Fig.35.  
Илл.35.

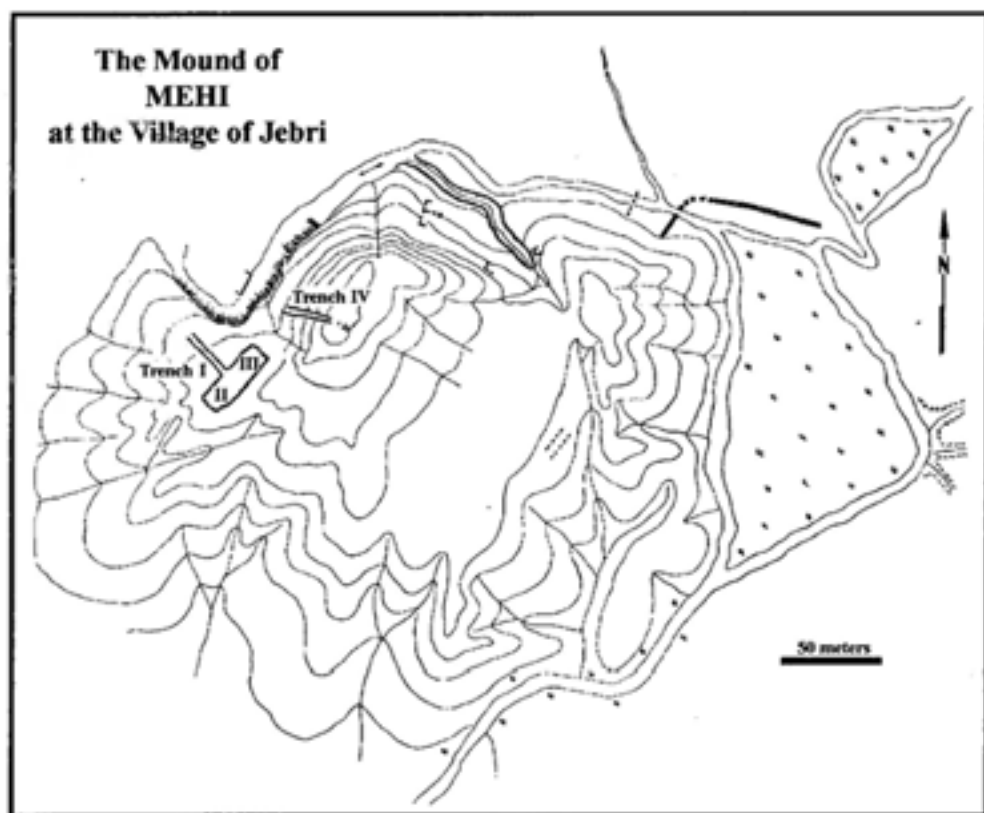

36.  
Fig.36.  
Mrrn.36.

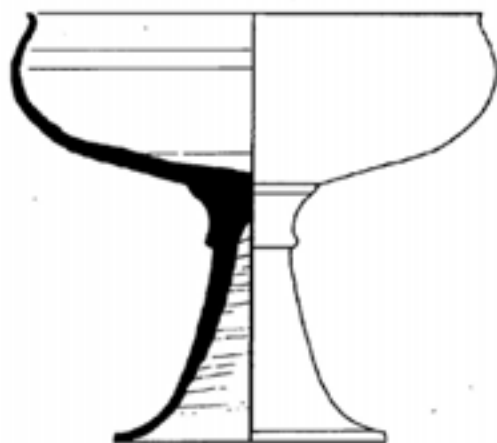

Mehi III.6.13

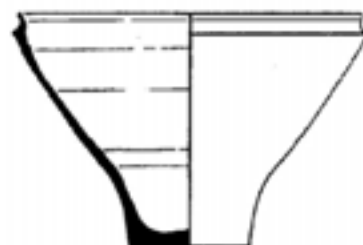

Mehi III.6.2

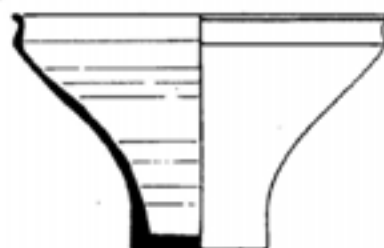

Mehi III.6.3



Mehi I.1.2



Mehi I.4.2

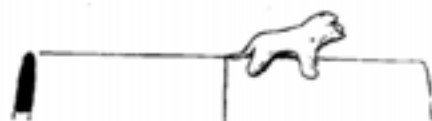

Mehi II.2.7.a

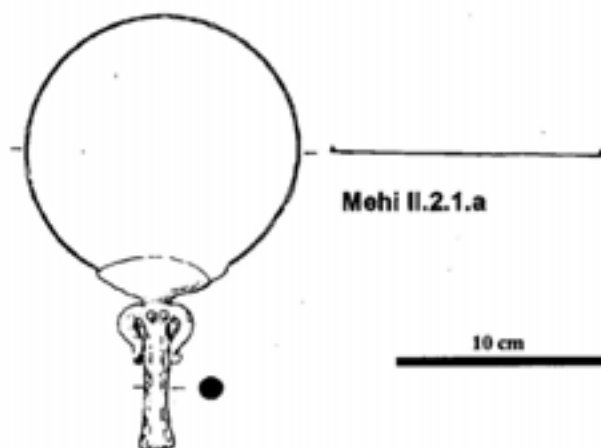

Mehi II.2.1.a

10 cm

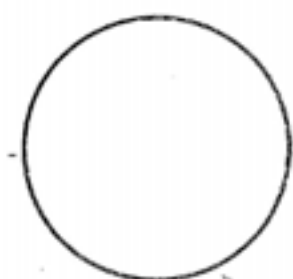

Mehi III.6.5

37.  
Fig.37.  
Mnn.37.

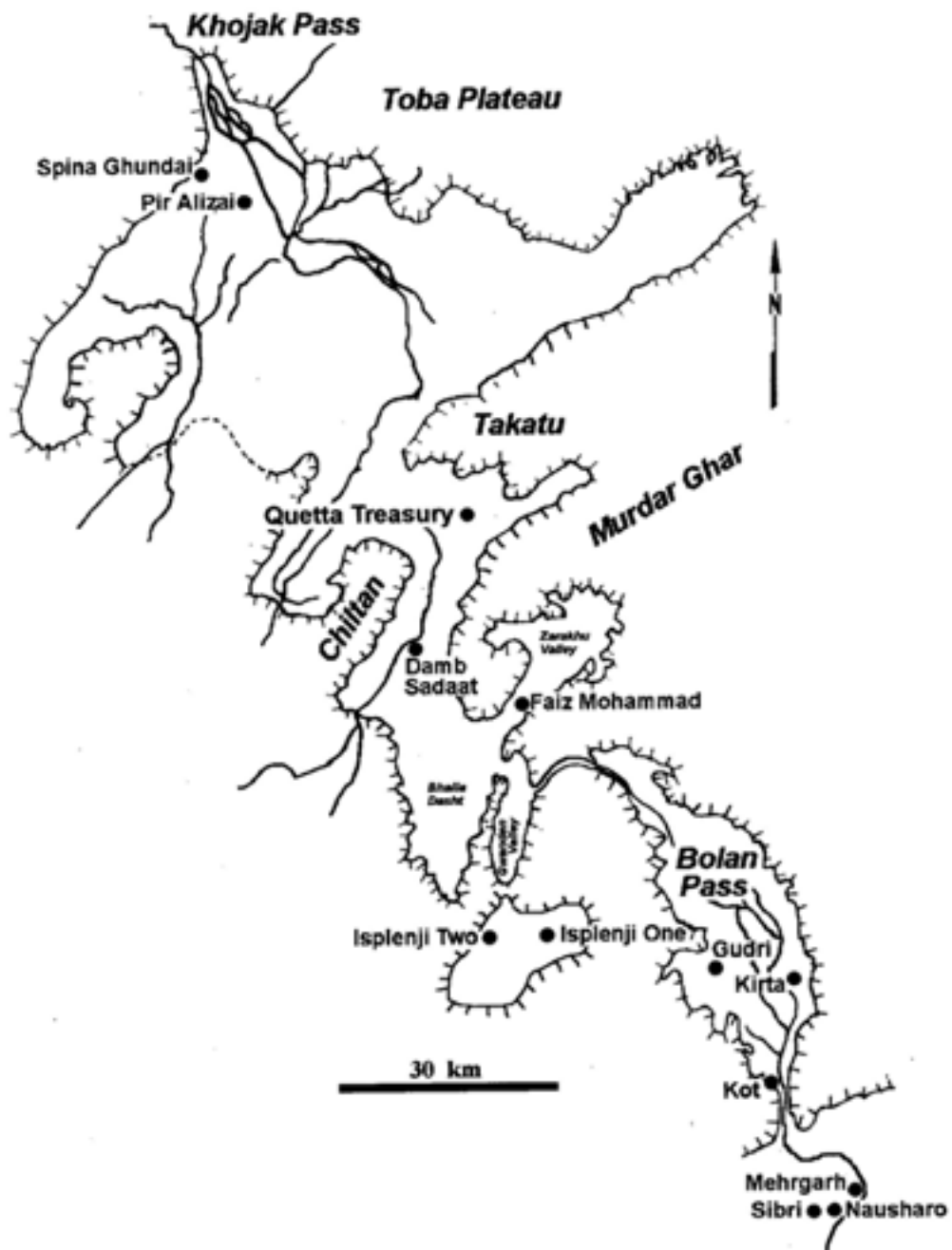

38.  
Fig.38.  
Mun.38.



39.  
Fig.39.  
Mnn.39.



40.  
Fig.40.  
Mnn.40.



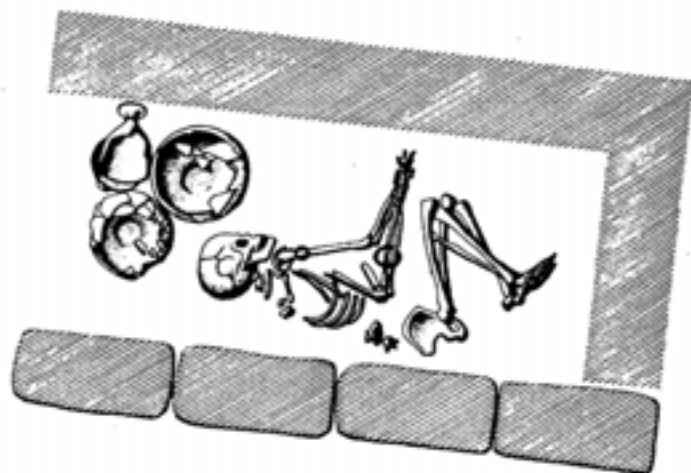

41.  
Fig.41.  
Mnn.41.

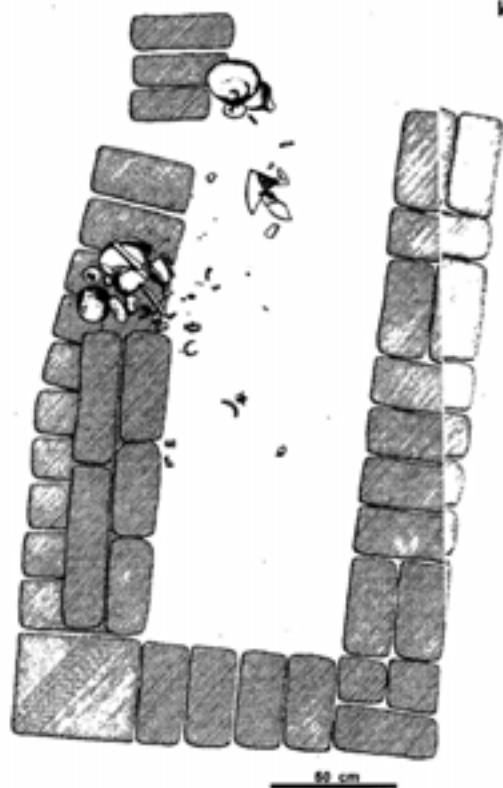

42.  
Fig.42.  
Mnn.42.

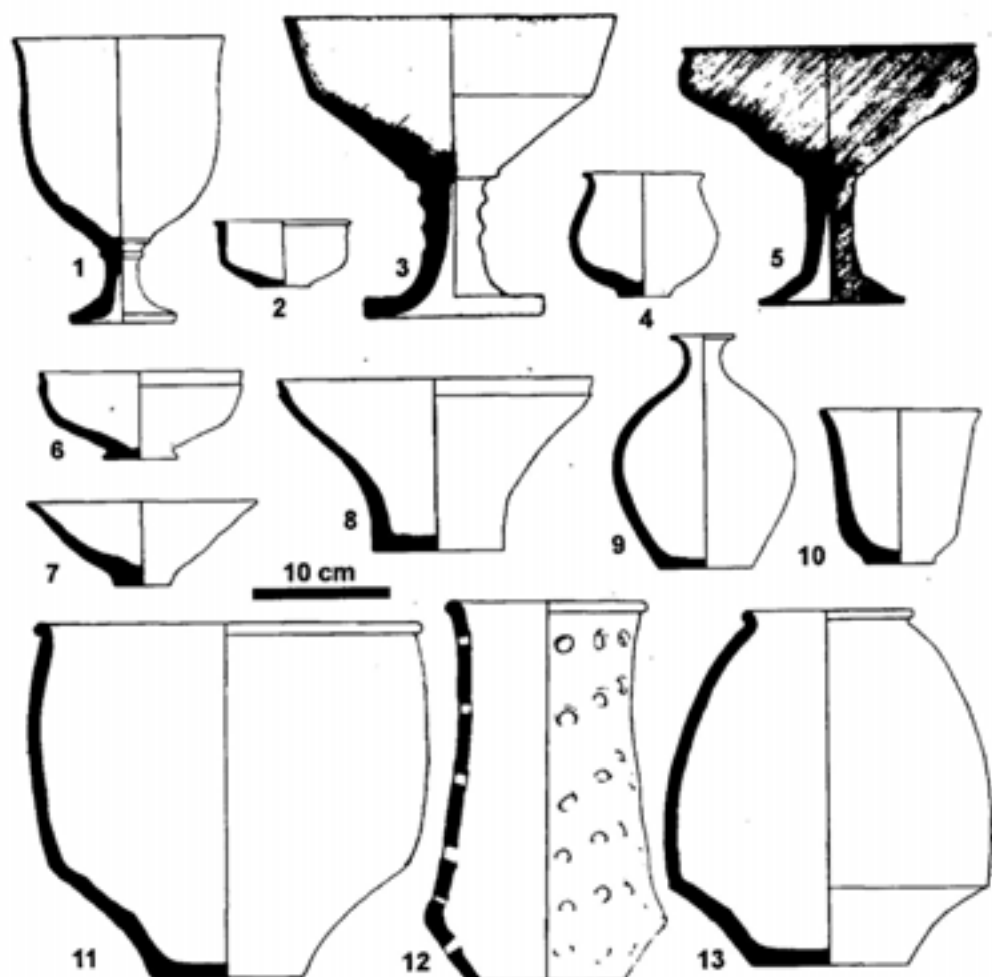

43.  
Fig.43.  
Mnn.43.

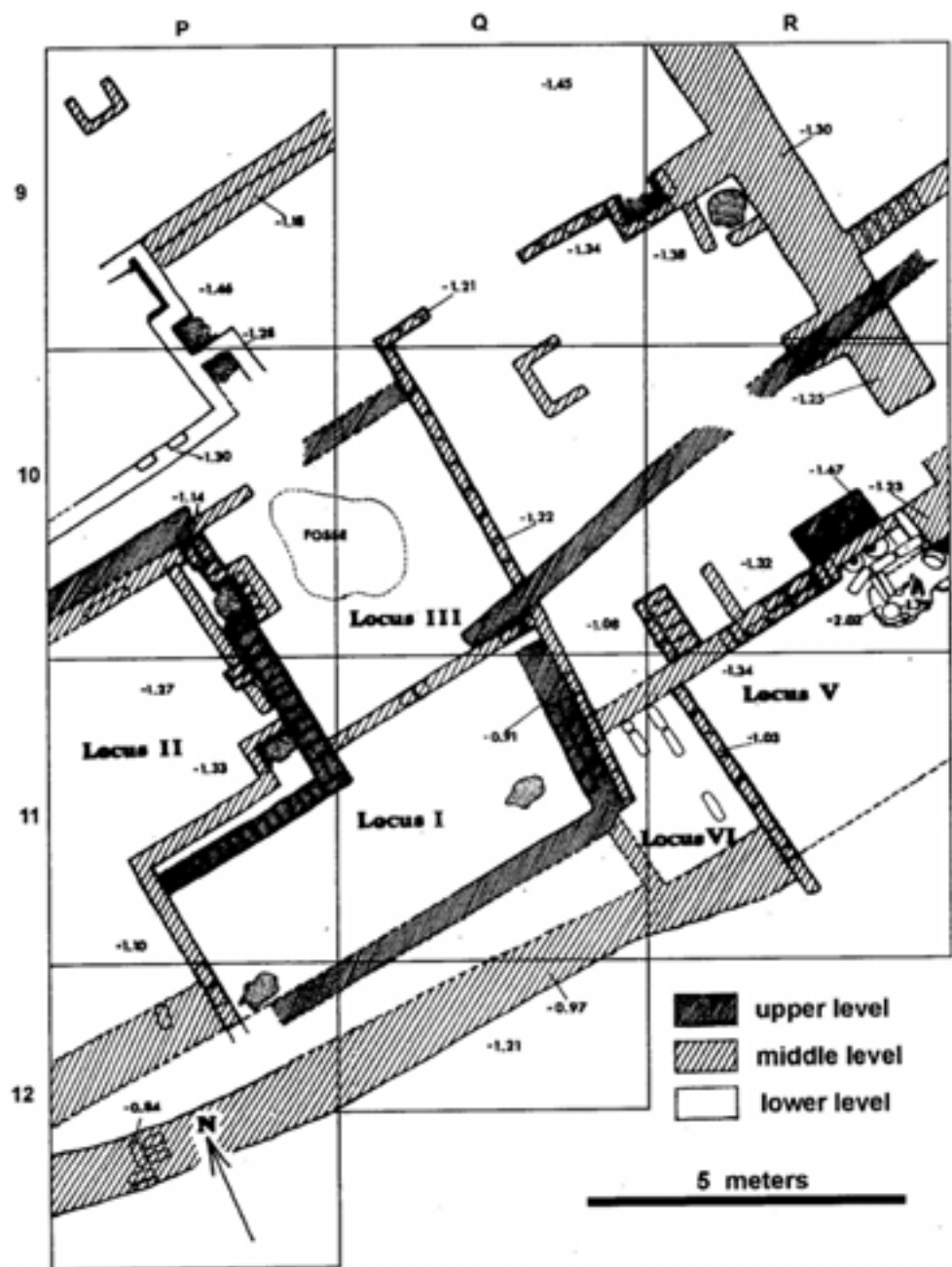

44.  
Fig.44.  
Wnn.44.

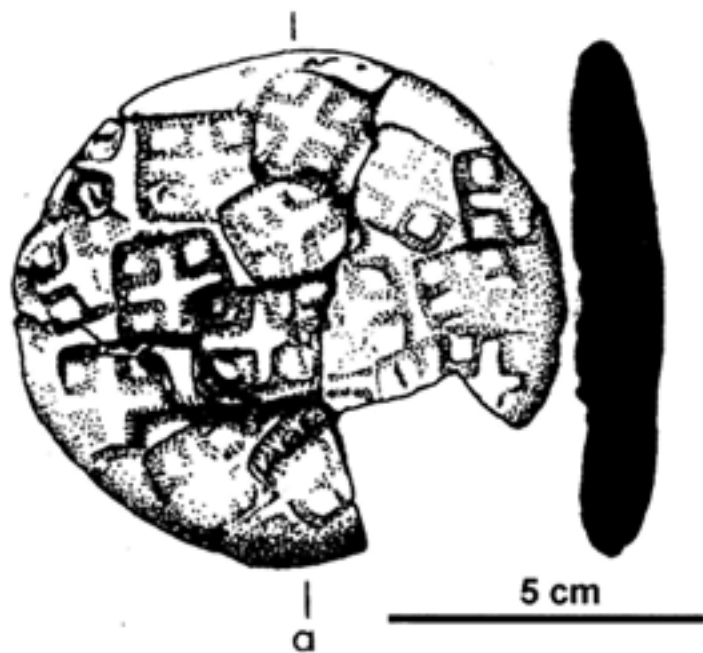

45.  
Fig.45.  
Mnn.45.

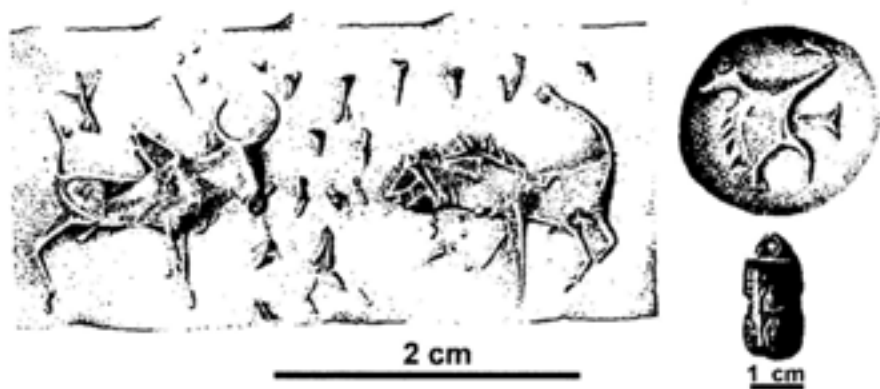

46.  
Fig.46.  
Mnn.46.



Design on the base  
of the cylinder seal



1 cm

47.  
Fig.47.  
Иnn.47.



48.  
Fig.48.  
Иnn.48

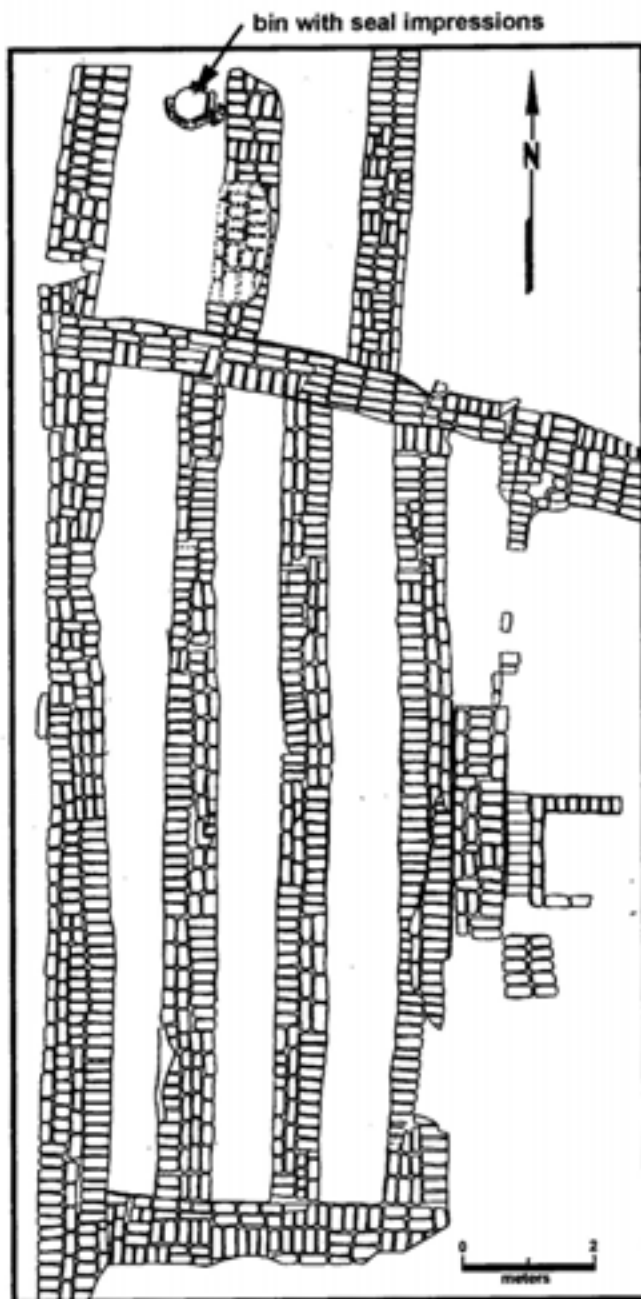

49.  
Fig.49.  
Wnn.49.



50.  
Fig.50.  
Mnn.50.

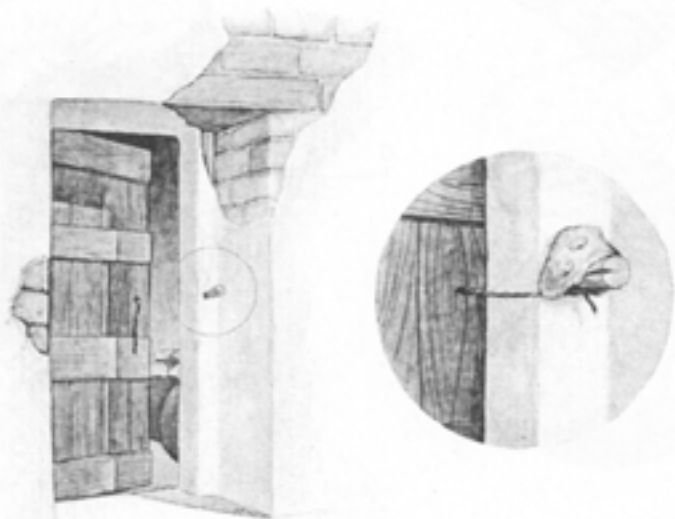

51.  
Fig.51.  
Mnn.51.

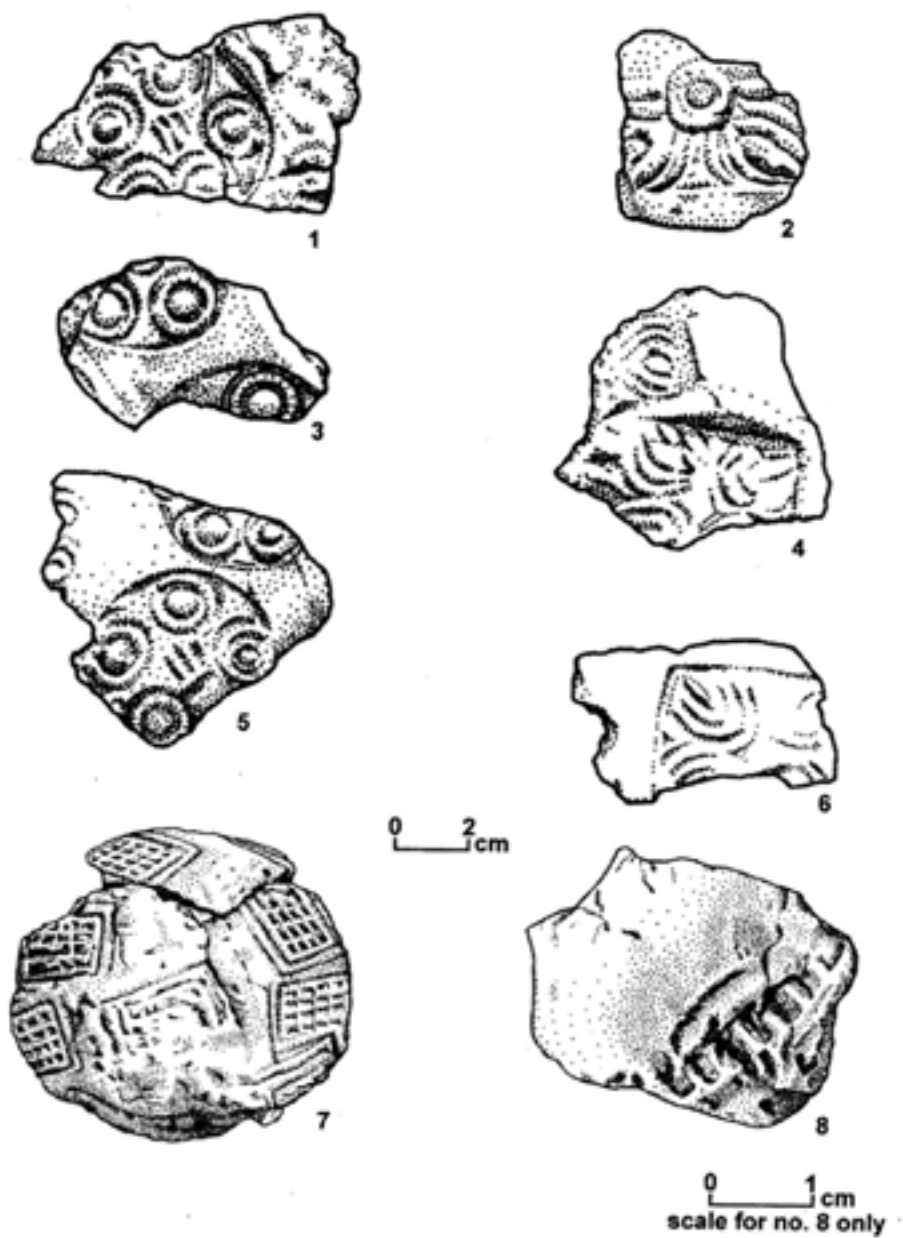

52.  
Fig.52.  
Mnn.52.



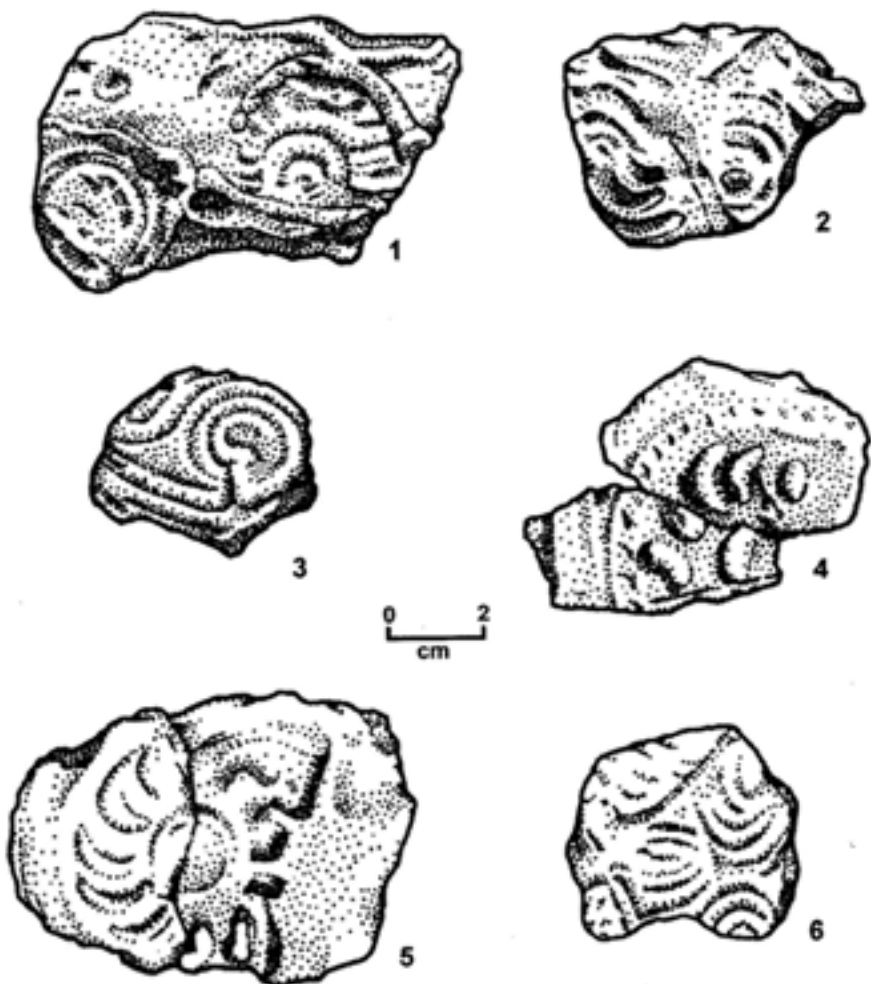

53.  
Fig.53.  
Mnn.53.

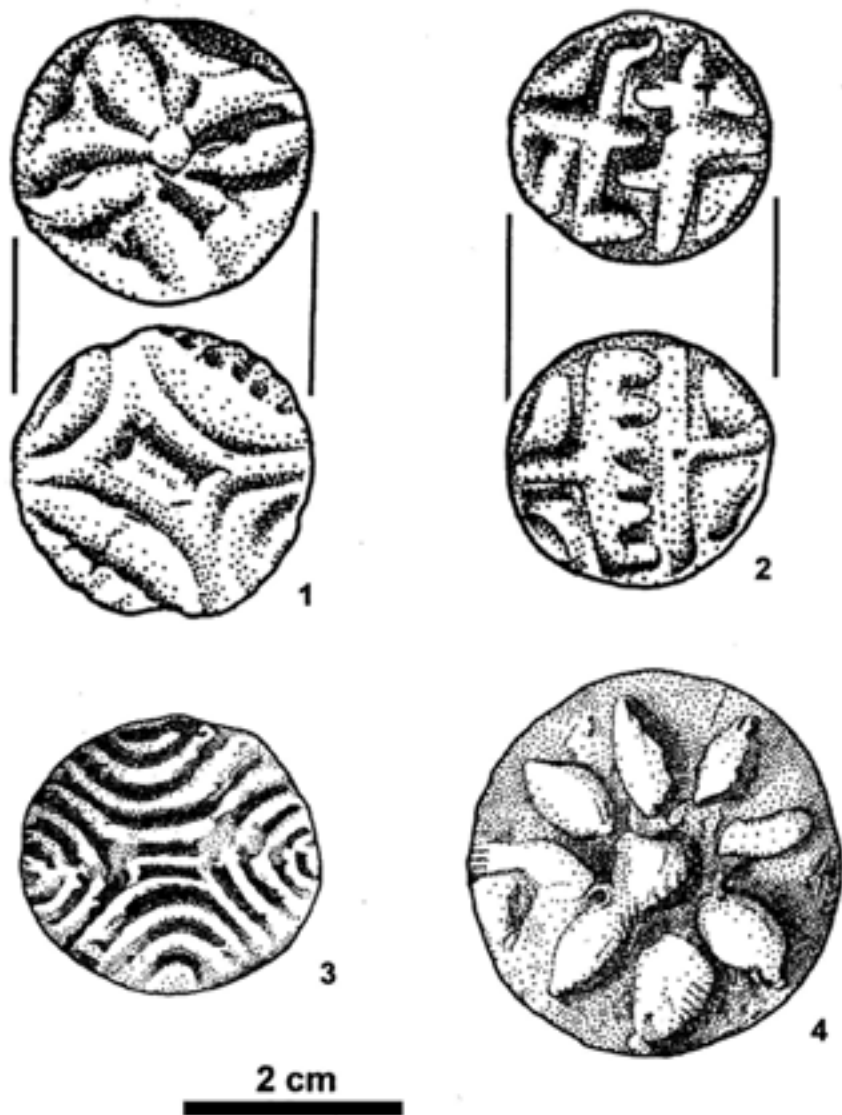

54.  
Fig.54.  
Mnn.54.

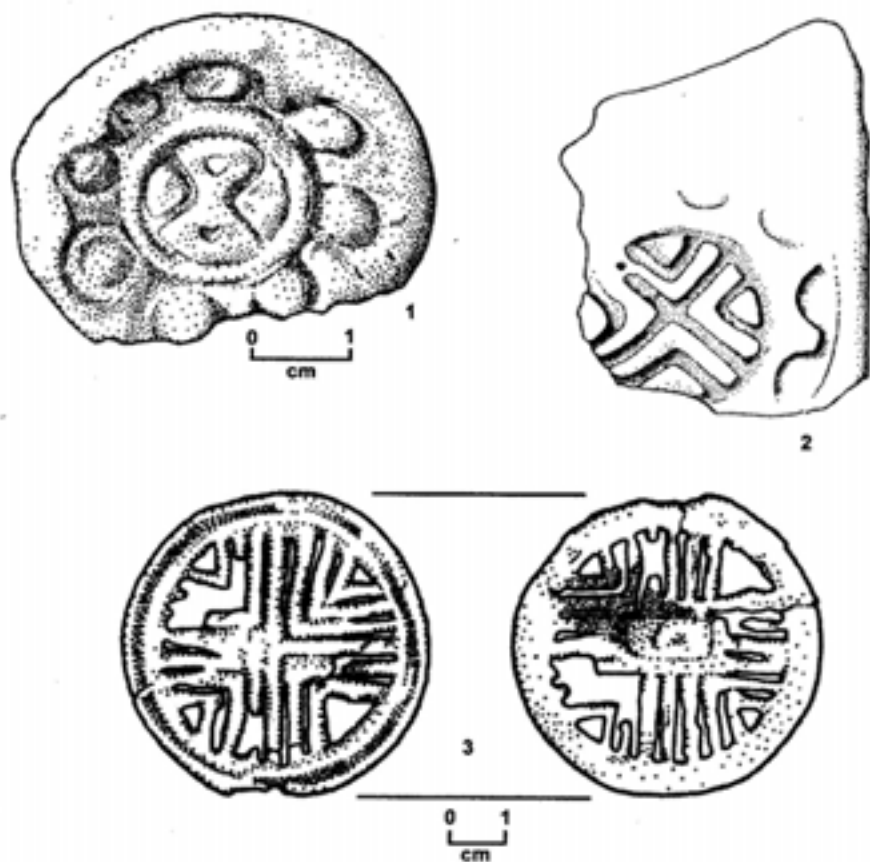

55.  
Fig.55.  
Mun.55.

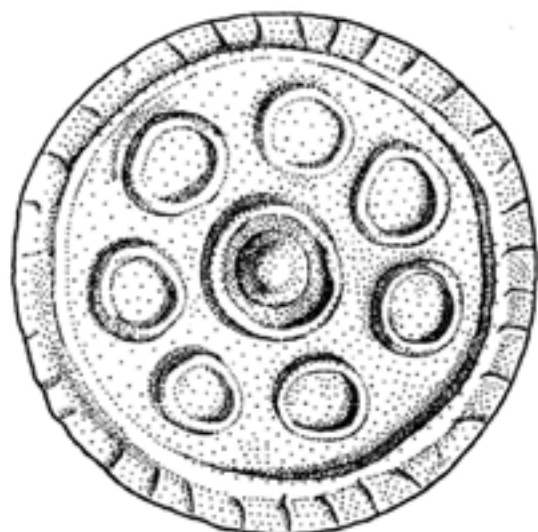

2 cm

Nindowari



2 cm

Kot Diji

56.  
Fig.56.  
Mun.56.



2 cm

57.  
Fig.57.  
Mnn.57.

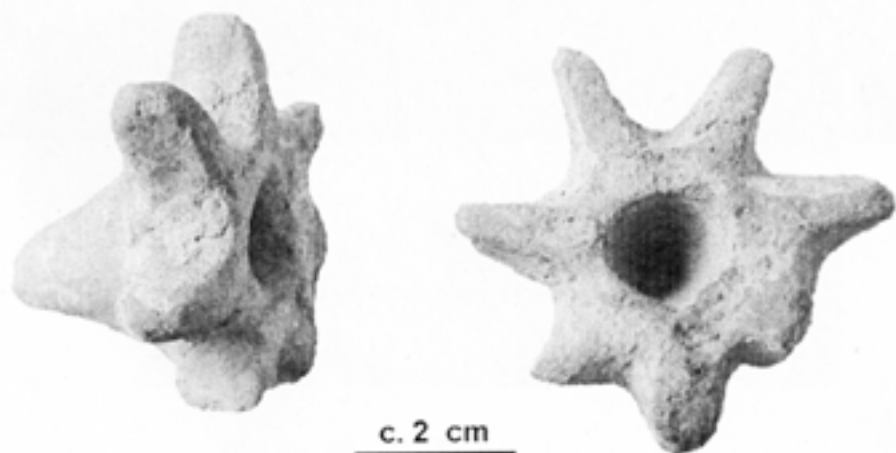

c. 2 cm

58.  
Fig.58.  
Mnn.58.

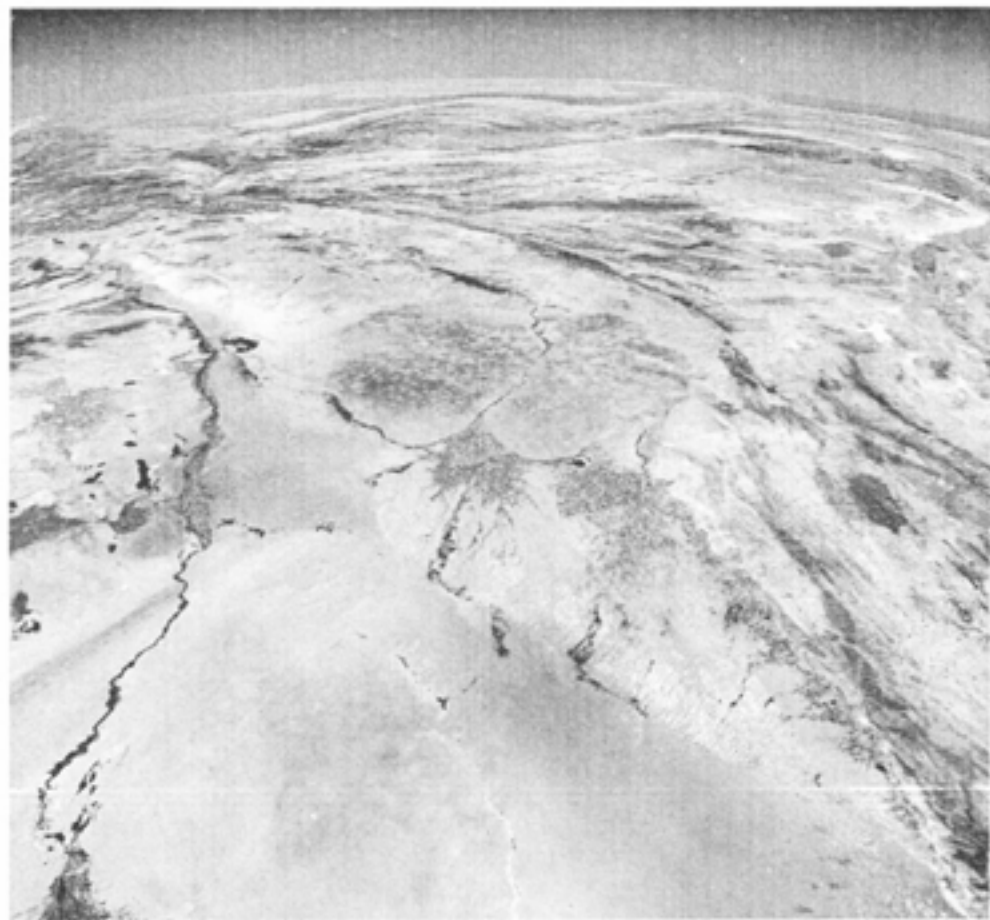

Fig.59. View of northern Turkmenistan (by Google EarthSat).

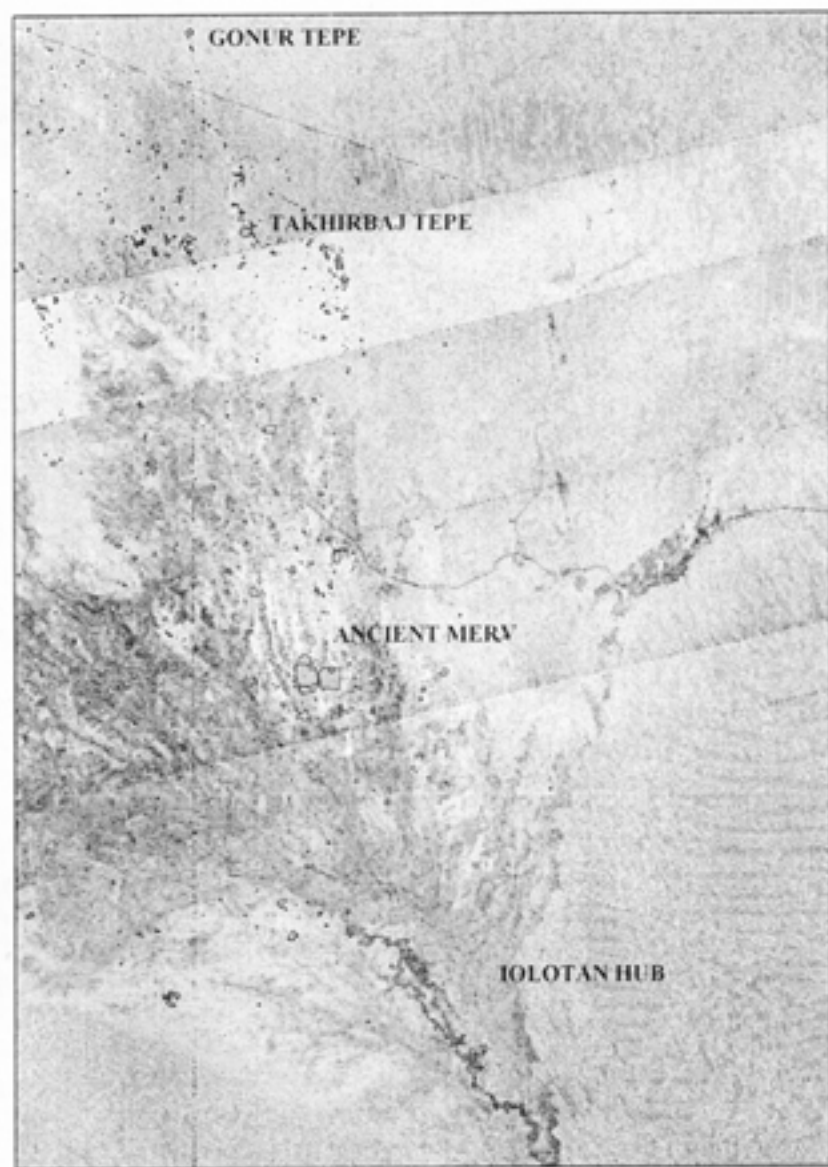

Fig. 60. Distribution of archaeological sites along the main palaeochannels on the basis of Corona overlapped on SRTM imagery.

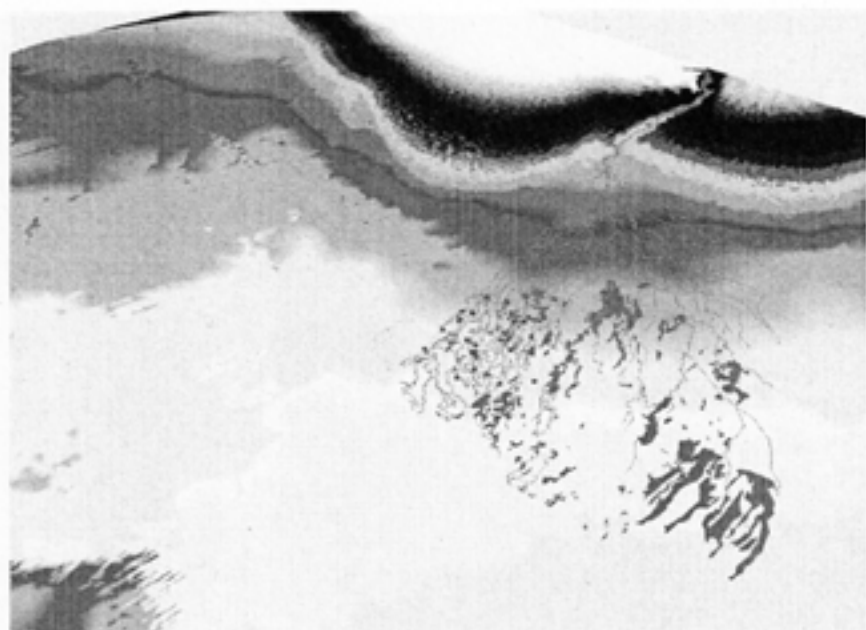

Fig. 61. Distribution of Middle Bronze Age sites.

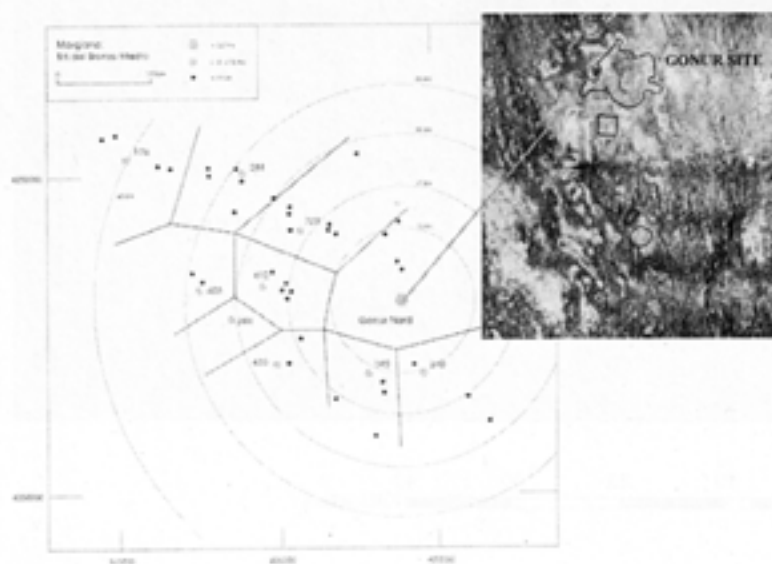

Fig. 62. Thiessen polygons analysis of Middle Bronze Age settlements (by Sandro Salvatori) and the ancient irrigation system of Gonur site.