

1. Tokinler — çyzgylar, belgiler edilen toýun göjekler

Fig.1. Tokens — earthenware balls with scratched signs from Gonur palace

Илл.1. Токины — глиняные шарики с нацарапанными знаками из гонурского дворца



2. Goňurdan tapylan myh ýazgysy bolan

Fig.2. Cylindrical seal with cuneiform from Gonur-depe and its impression.

Илл.2. Цилиндрическая печать с клинописью из Гонур-депе и ее оттиск

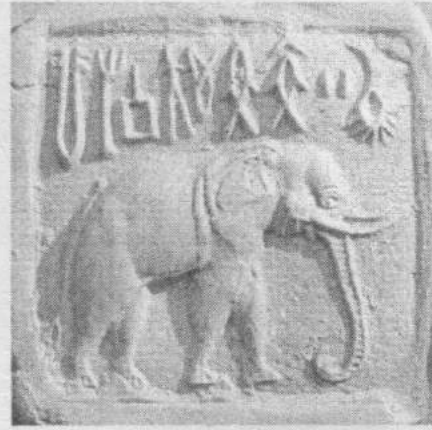

3. Goňurdan tapylan Harappa möhüri. Asyl nusgasy we onuň basgysy
 Fig.3. Harappian seal from Gonur-depe
 Илл.3. Харалпская печать из Гонур-депе

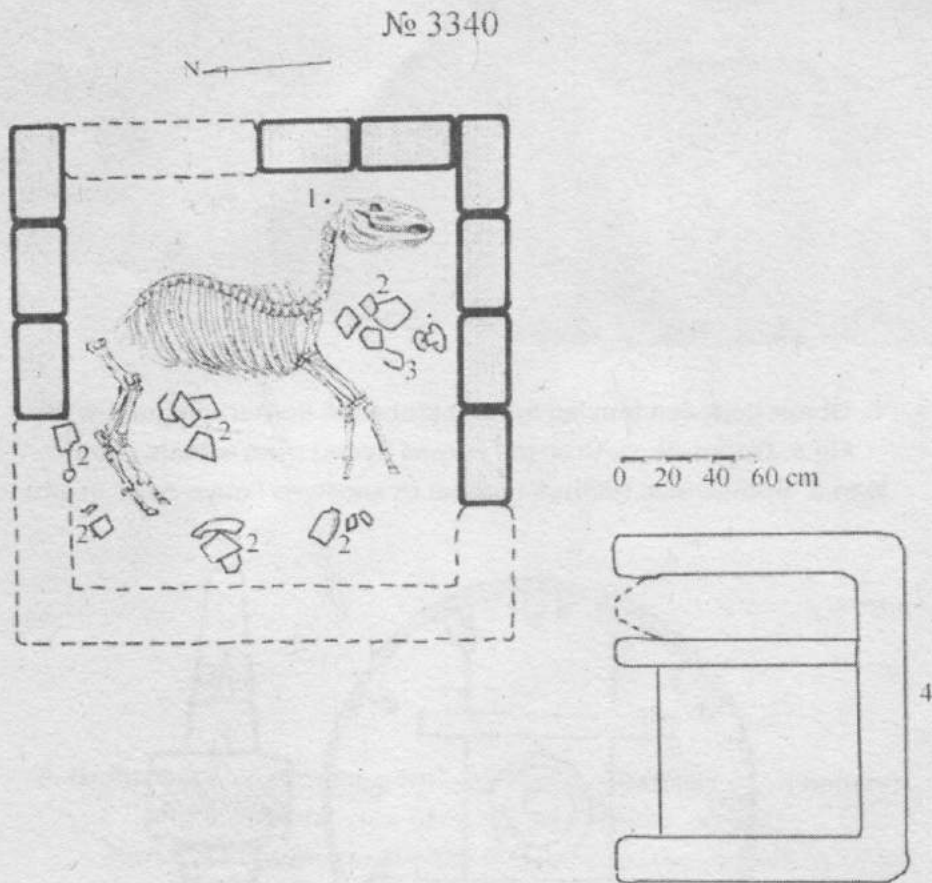

4. Demirgazyk Goňuryň guburhanasyndaky (N 3340) taýçanagyň jaýlanan ýeriniň plany
 Fig.4. Plan of the stallion burial (# 3340) at the royal necropolis of the North Gonur
 Илл.4. План погребения жеребенка (№ 3340) на царском некрополе Северного Гонура



5. Gonur depeden tapylan burunç arabanyň tigirleriniň gurşawlary
Fig.5. Gonur-depe. Bronzed felloes (tyres) from wheels in situ
Илл.5. Бронзовые ободья (шины) от колес из Гонур-депе in situ

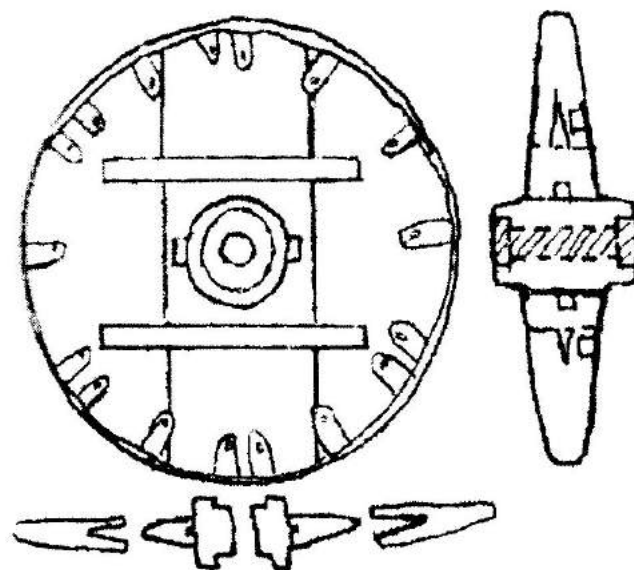

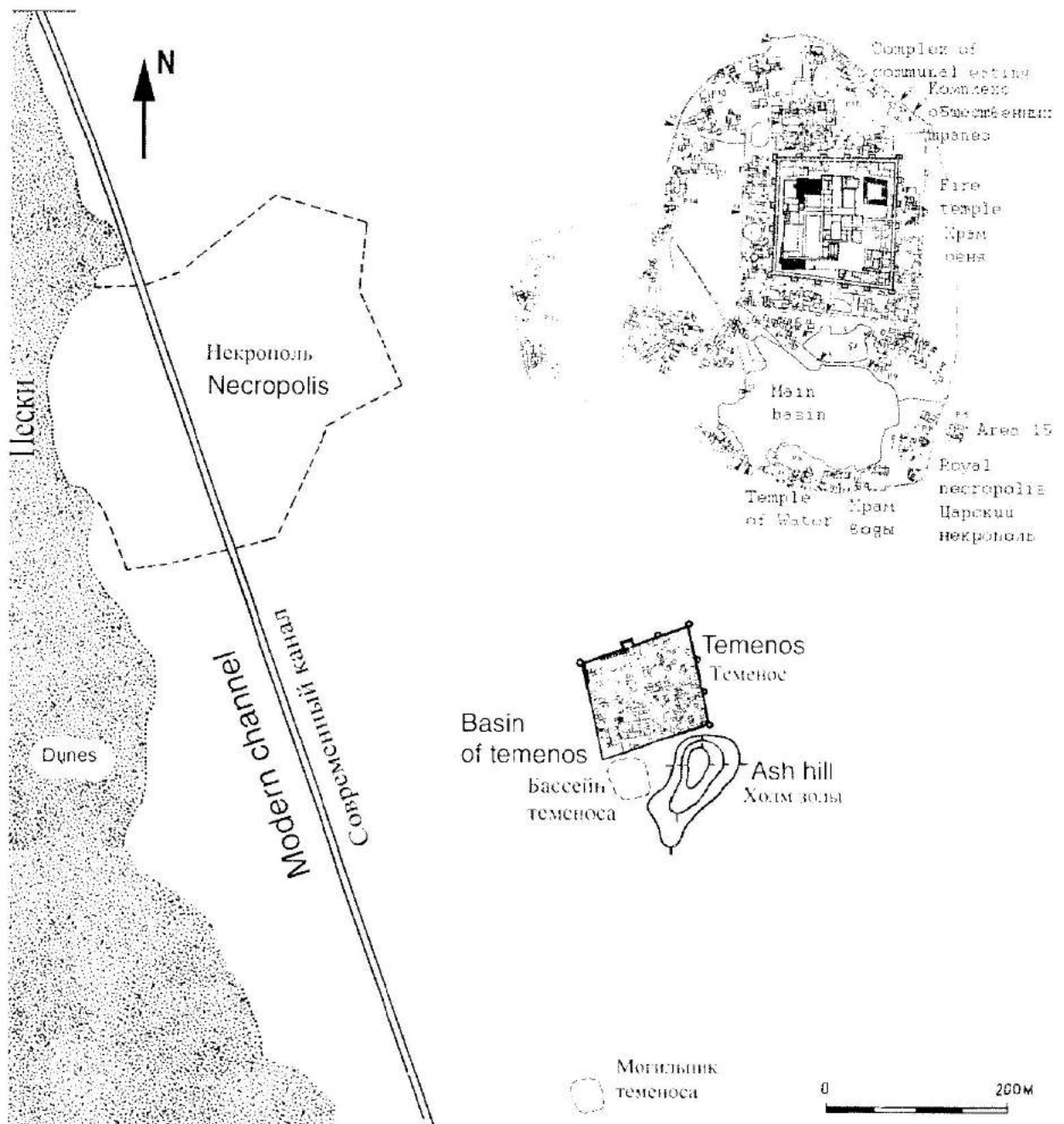

6. Goňur depäniň umumy görnüşiniň plany (2006-njy ýylyň bahary)

Fig.6. General view of Gonur Depe (2006, spring)

Илл.6. Ситуационный план Гонур-депе (весна 2006 г.)

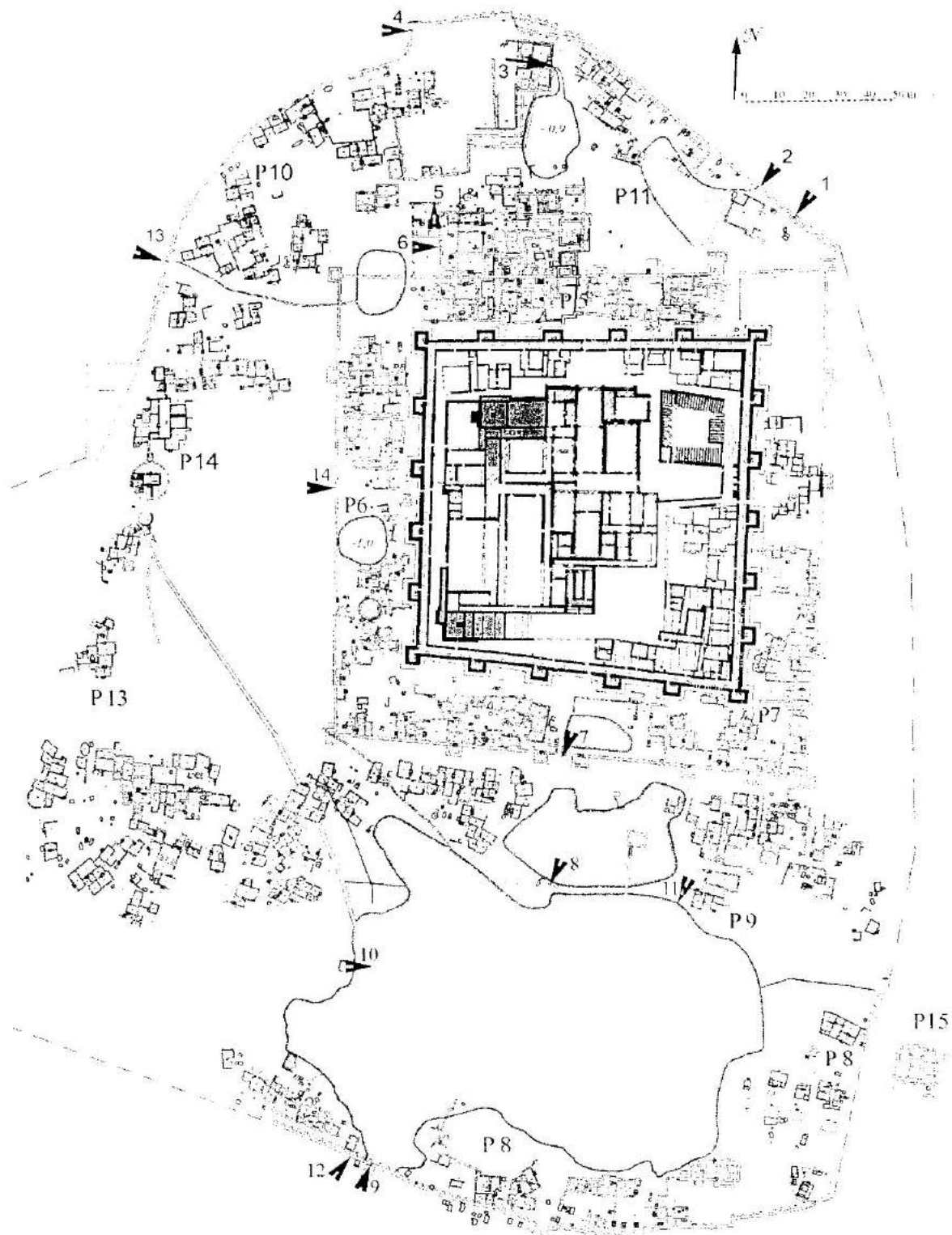

7. Goňurdaky köşk - ybadathana toplumynyň umumy görnüşiniň plany (2006-njy ýylyň bahary)

Fig.7. Plan of the central part of the Palace-temples complex of the North Gonur (2006, spring).
Squares of communal eating are shaded

Илл.7. Общий план центральной части дворцово-храмового комплекса Северного Гонура
(весна 2006 г.). Штриховкой выделены площади общественных трапез

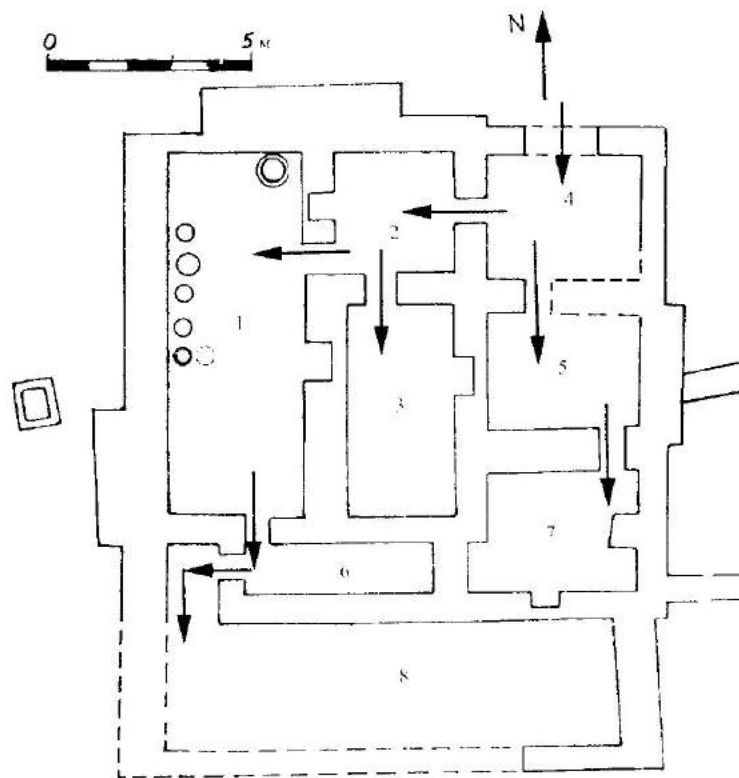

8. Margiananyň düzümindäki iň gadymy soma-haoma köşgüniň plany
(Demirgazyk Goňurdaky 15-nji gazuw meýdany)

Fig.8. Plan of the earliest in Margiana Soma-Khaoma Temple (Area 15 of North Gonur)

Илл.8. План самого раннего в системе всей Маргианы храма сомы-хаомы
(Раскоп 15 Северного Гонура)

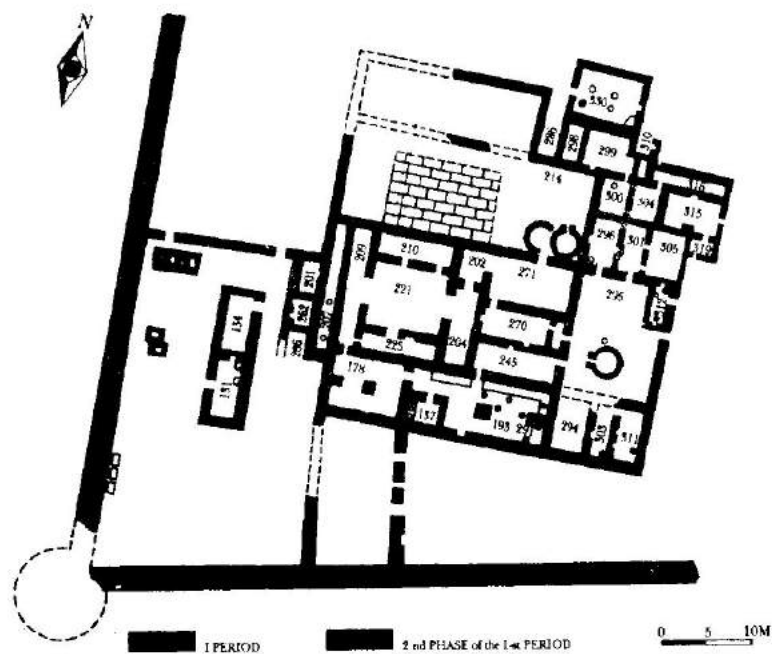

9. Goňurdaky temenosyň (mukaddes meýdanyň) çägendäki köşgüň plany

Fig.9. Temenos of Gonur. Plan of the temple

Илл.9. План храма на территории теменоса Гонура

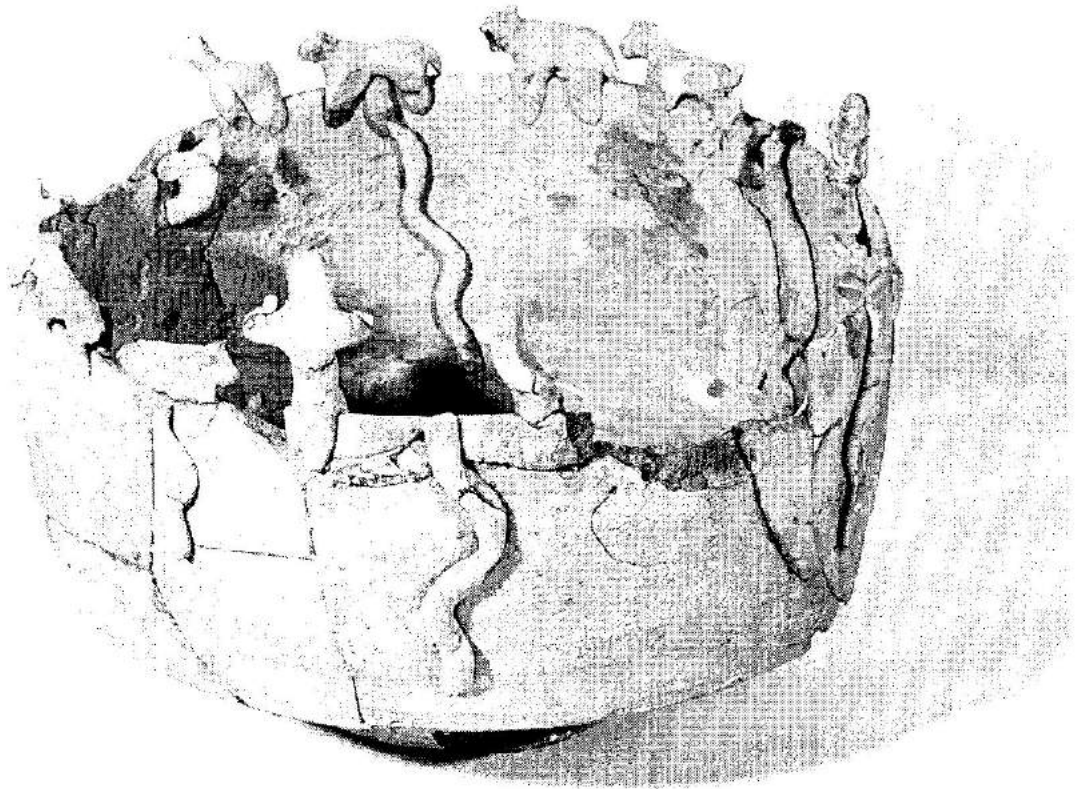

10. Togalak-1 ybadathanasyndan tapylan dini dessur ähenli gap
 Fig.10. Togolok 1 temple. Vessel with modelled frieze on rim
 Илл.10. Сосуд из храма Тоголок 1 с наклепным фризом на венчике

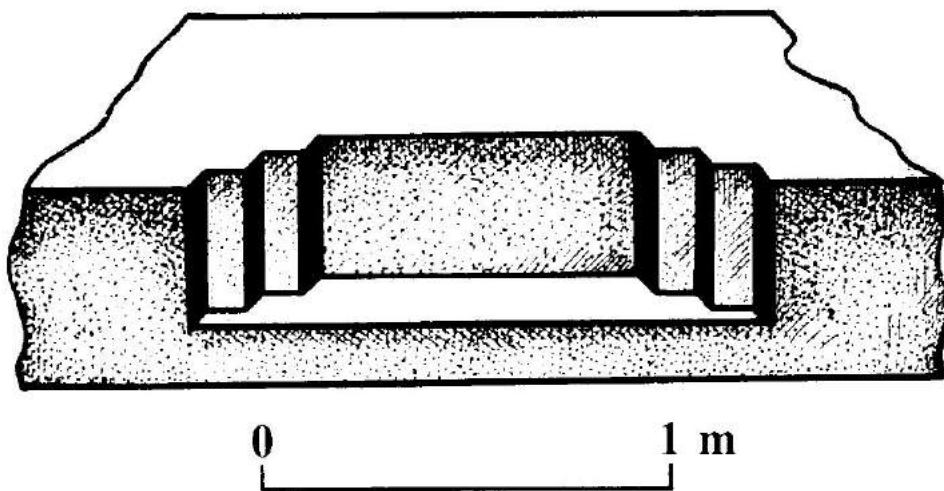

11. Goňurdaky ymaratlaryň birindäki basganjakly tagçanyň görnüşi
 Fig.11. Gonur palace. "Blind windows" in one of halls
 Илл.11. "Слепые окна" в одном из помещений дворца Гонура

грушевидная
pearform

однокамерная
one-chamber
oven

двухкамерная
с 'валиком'
double-oven
with 'bolster'

двухкамерная с
уступом
double-oven with
shelf

трехкамерная
triple-oven

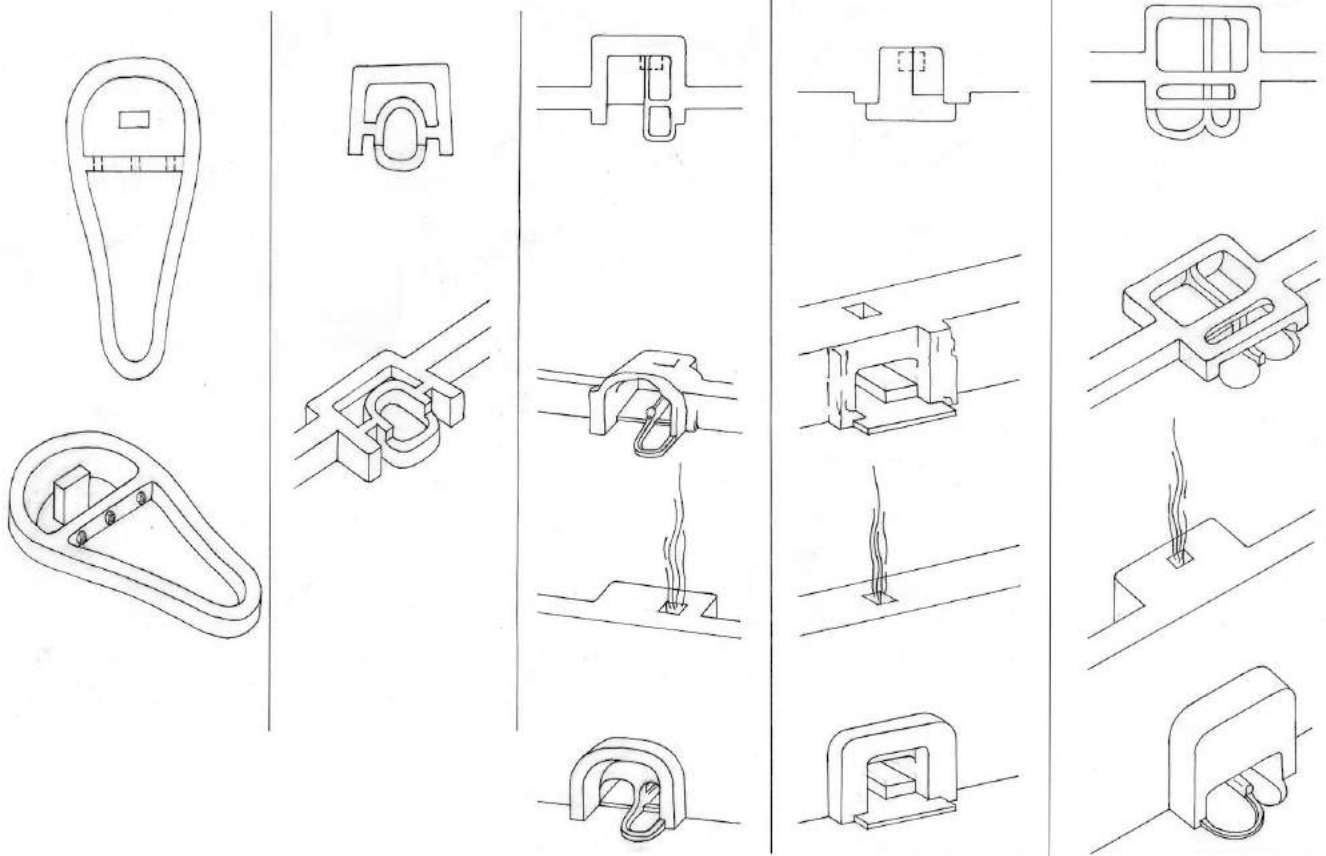

12. Demirgazyk Goňurdaky dini döp-dessur äheňli ögjaklaryň görnüşleri
Fig.12. Types of cult ovens of North Gonur
Илл.12. Типы культовых печей Северного Гонура

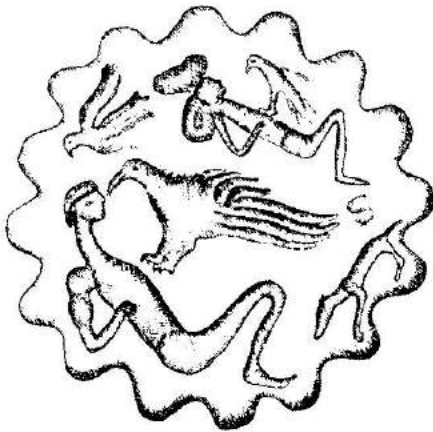

13. R.Garneriň kolleksiyasynda saklaýan Baktriýanyň bürünç möhürindäki şekil
Fig.13. Drawing of the image on the bronze seal from Bactria (R. Garner's collection)
Илл.13. Прорисовка изображения на бронзовой печати из Бактрии, хранящаяся в коллекции Р. Гарнера

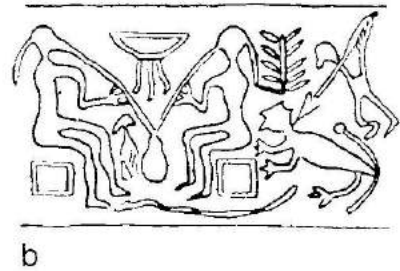
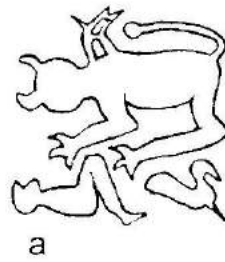

14. Togolak-21 ybadathanasyndan tapylan tumaryň ýüzündäki meňzeş şekiller (a) we siro-hett silindrden şekiller
Fig.14. Images on the amulet from Togolak-21 (a) and Siro-Hittite cylinder (b)
Илл.14. Сходные изображения на амулете из храма Тоголок-21 (а) и сиро-хеттском цилиндре (б)

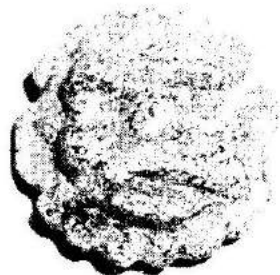
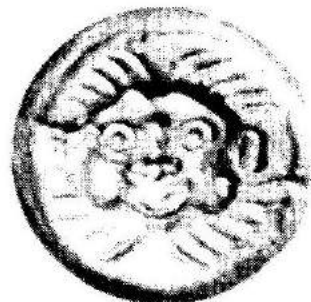
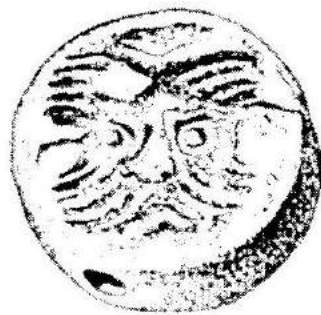

15. Karasaspanyň (?) şekilleri. a) Goňurdaky guburhana, N 2790. b) Goňurdaky guburhana N 1200. c) Margiana, Togolok oazisi. d-i) Baktriýanyň guburhanalaryndan

Fig.15. Kersaspa's(?) images. a) Gonur necropolis, burial № 2790; b) Gonur necropolis, burial № 1200; c) Margiana, Togolok oasis; d-i) from the plundered tombs of Bactria

Илл.15. Изображения Керсаспы (?): а) некрополь Гонура, погребение № 2790. б) некрополь Гонура, погребение № 1200; в) Маргиана, Тоголокский оазис; г-и) из некрополей Бактрии



16. Togolok-21 ybadathanasyndan tapylan mermerden ýasylan öňüziň kellesi
Fig.16. Marbled bull's head from the Togolok 21 temple
Илл.16. Мраморная голова быка из храма Тоголок 21



17. Goňurdepedäki guburlaryň görnüşleri.
a) "Dahma" — Demirgazyk Goňurdaky köşgüň çägindäki 92 -nji otag
Илл.17. Типы погребений Гонур Депе: а) "Дахма" — пом. 92 Дворца Северного Гонура

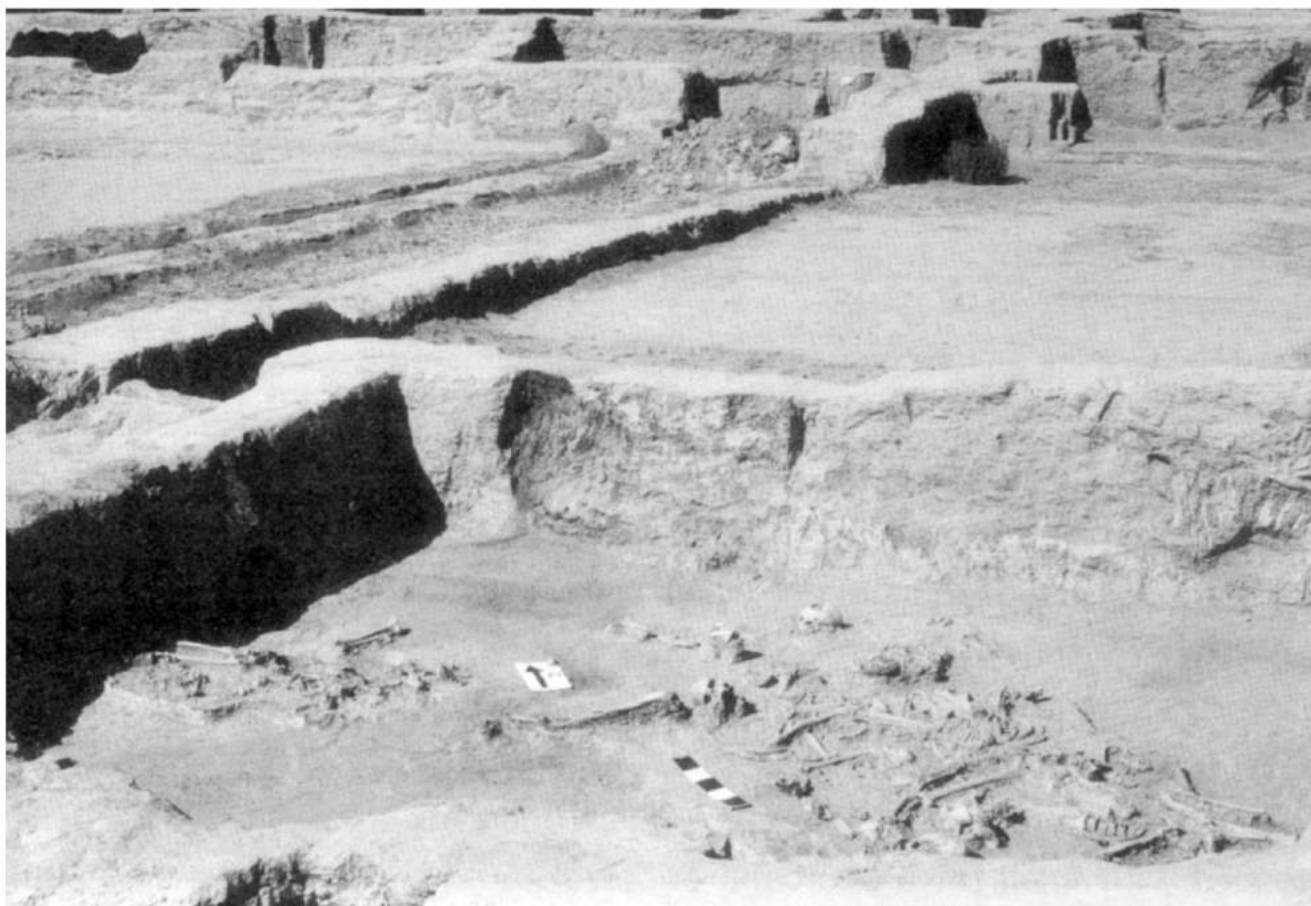

b,c) Goňurdaky guburhana (N 412). Bölekleýin guburlar
b,c) Фракционное погребение (№ 412) некрополя Гонура



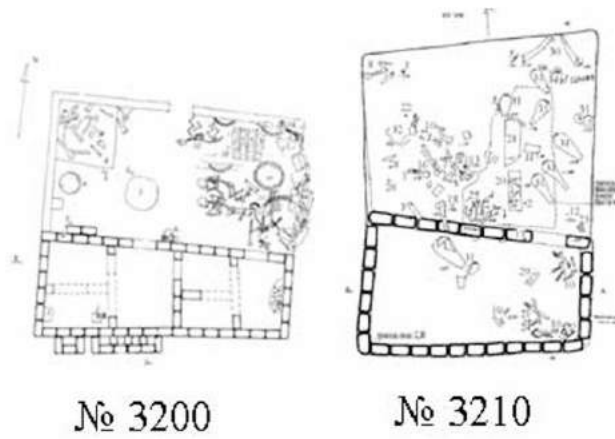
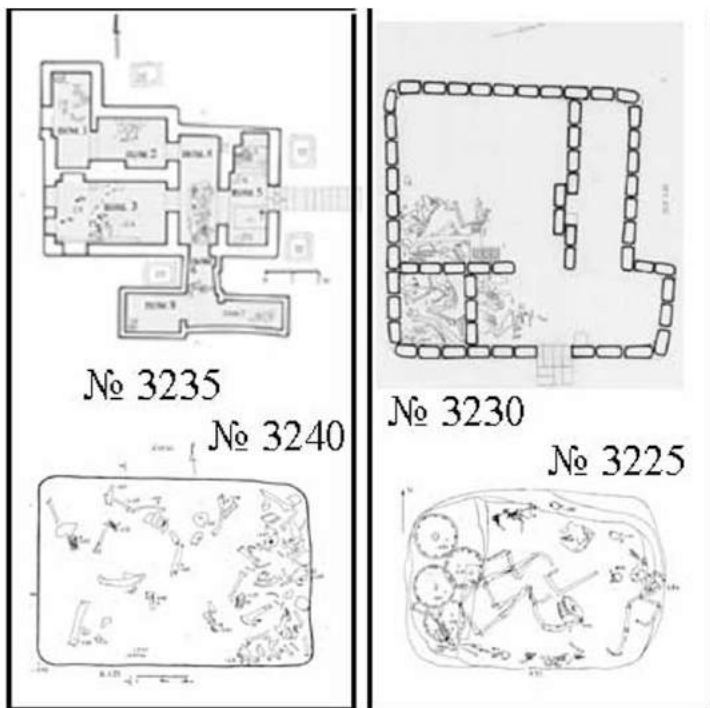

I type

II type

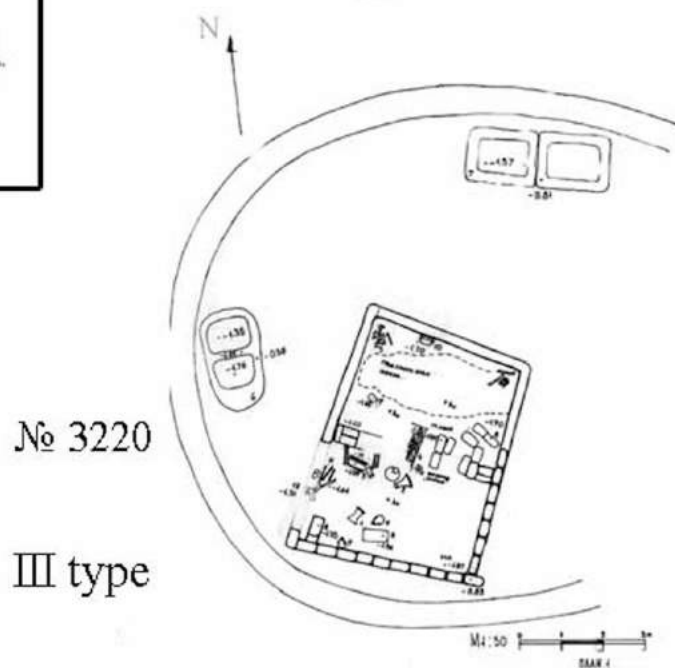

d) Demirgazyk Goňurdaky patyşalaryň guburhanasy
 d) Царские гробницы Северного Гонура

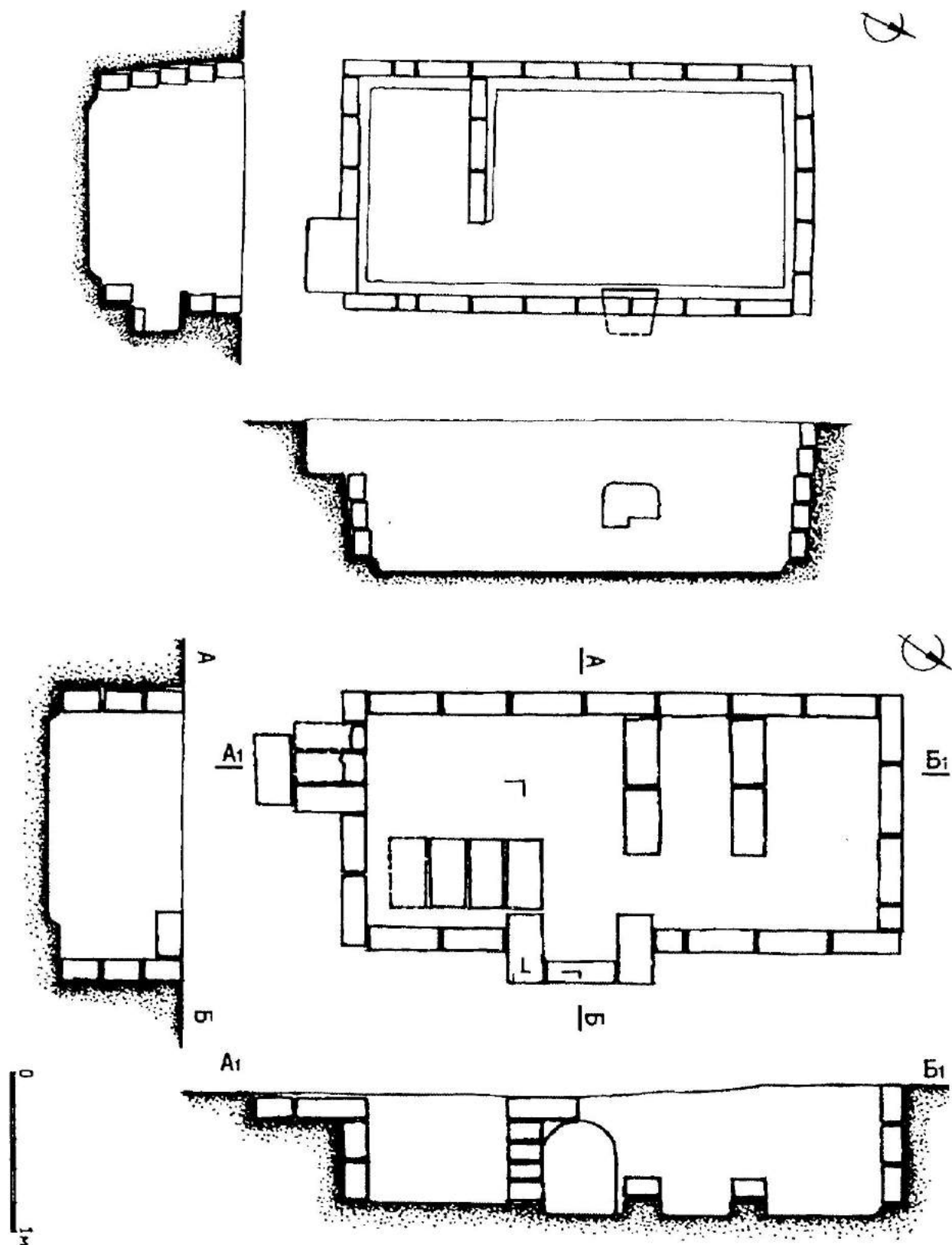

е) Guburhanadaky aýry-aýry mazarlar (1- № 555; 2 — № 585; 3 — № 1750)

е) Камерные гробницы некрополя (1- № 555; 2 — № 585; 3 — № 1750)

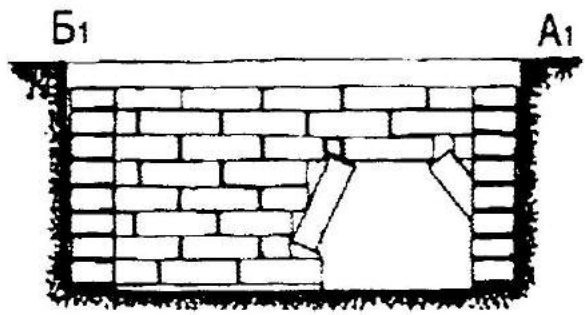
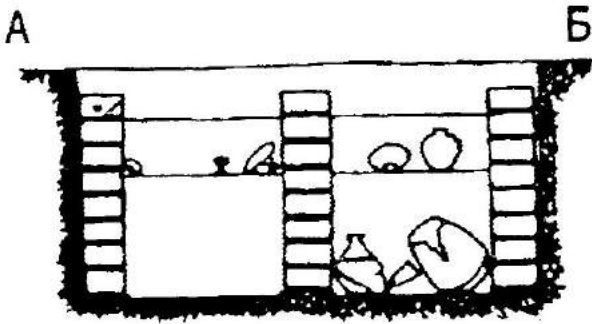
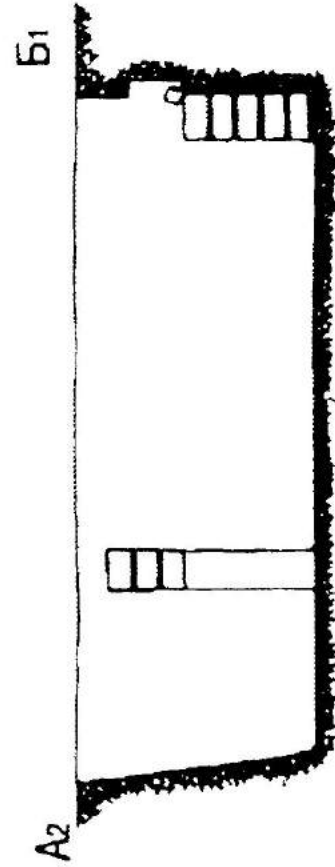
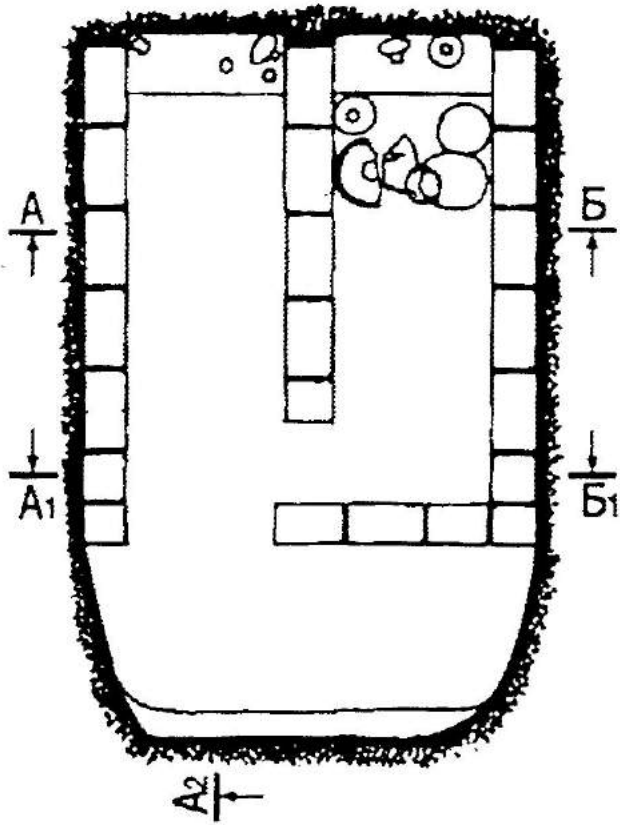

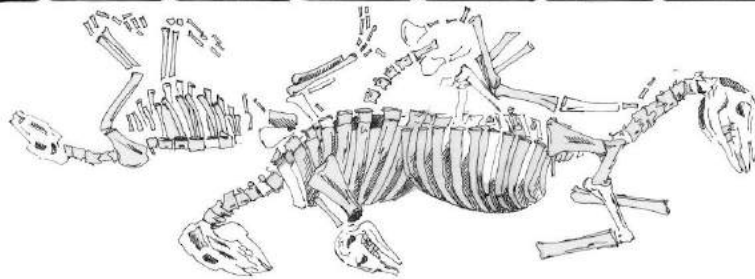
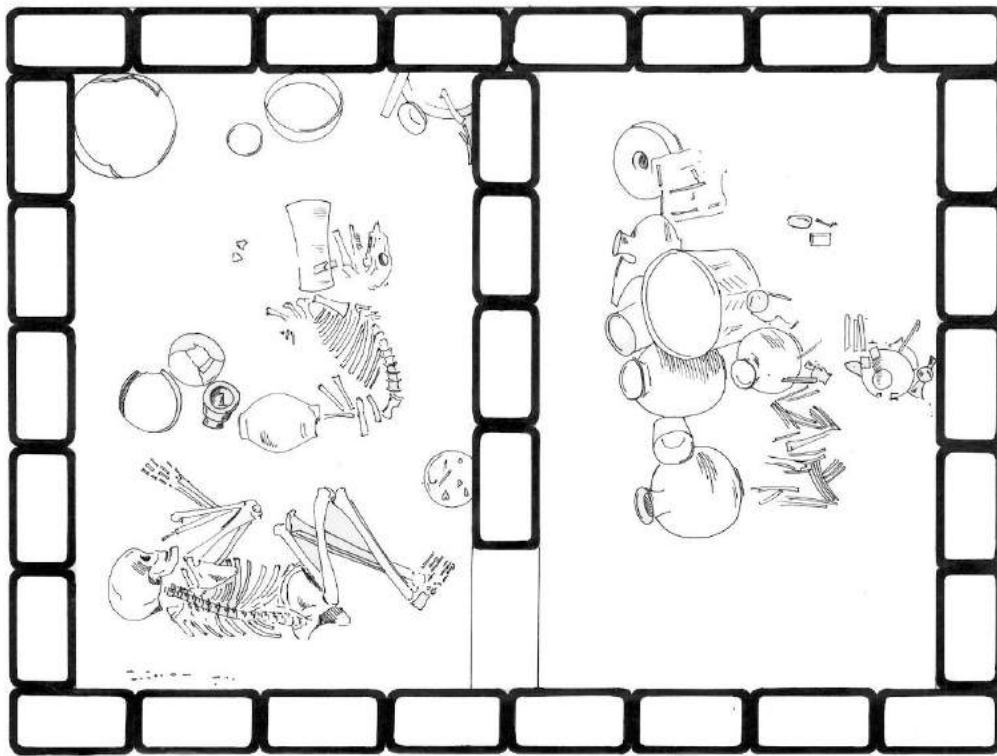

3310

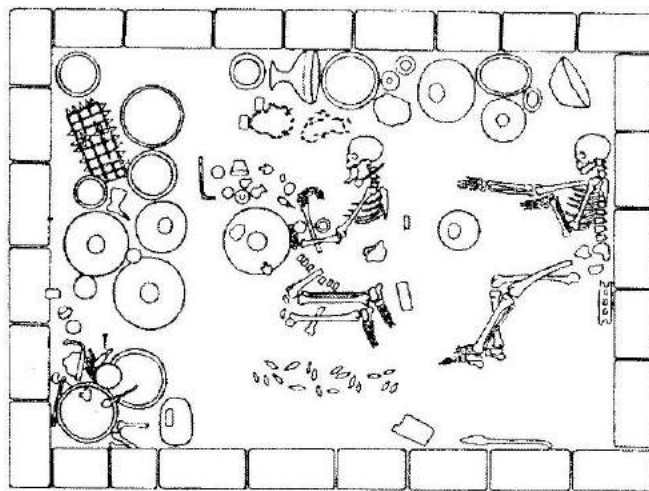

#2900

f) Demigazyk Goňur. Guburhananyň daşynyň çig kerpiçden örümleri
 f) Цисты из сырцовых кирпичей Северного Гонура (1 — № 3310; 2 — № 2900)

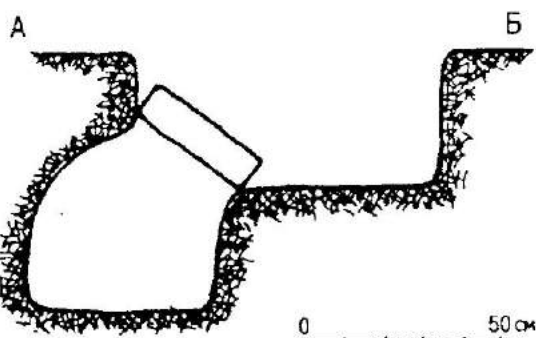
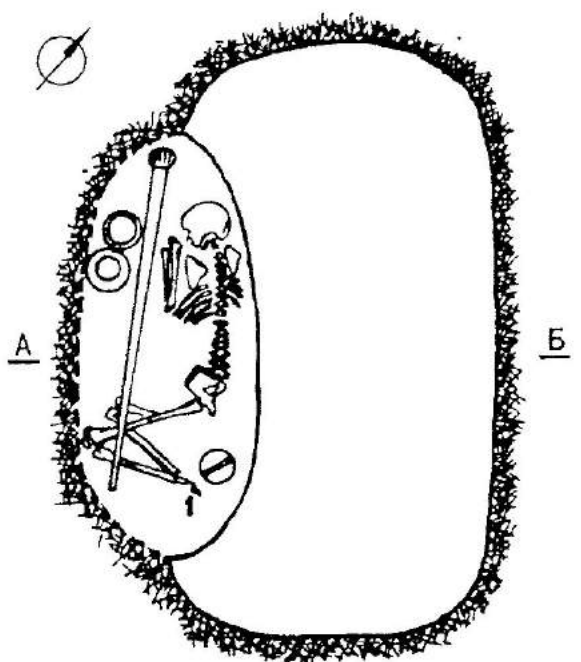

g) Dikligine gazylan mazar. Goñur guburhanasy N 1500

г) Подбойное (шахтное) захоронение № 1500 некрополя Гонура

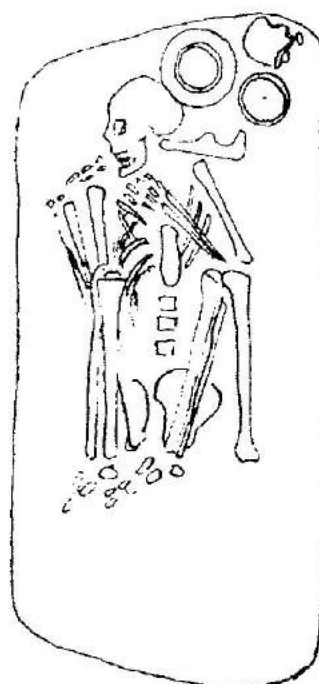

h) Çukur görnüŝde uzynlygyna gazylan mazar. Goñur guburhanasy N 1389

h) Ямное погребение № 1389 некрополя Гонура

18. Demirgazyk Goñur. N 2999 guburdan tapylan çaga kelleçanany boýunça gaýtadan dikeldilen grafiki ŝekil. T.S.Baluýewanyň işi

Илл.18. Графическая реконструкция облика ребенка по черепу из погр. 2999 Северного Гонура. Работа Т.С. Балуевой

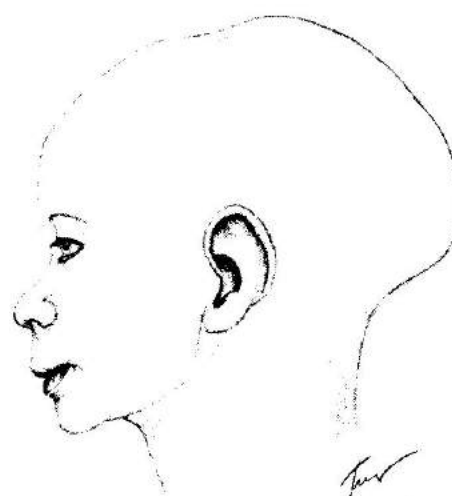

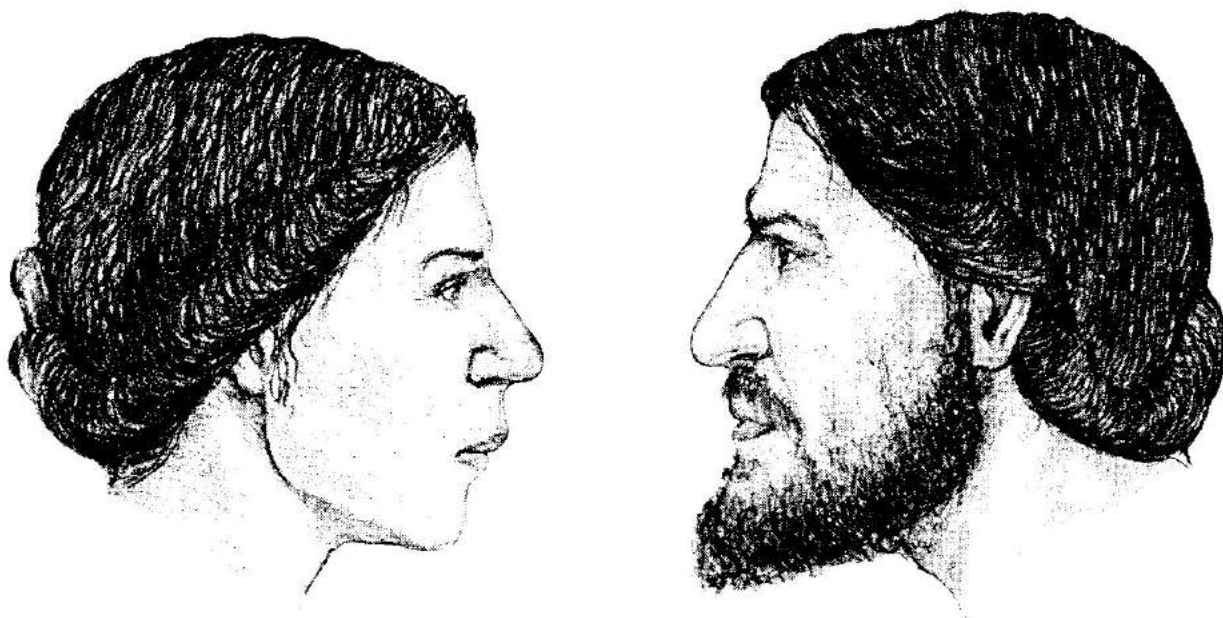

19. Kelleçanaklar boýunça adamlaryň daşky keşbiniň rekonstruksiyasy.
a) N 3343; b) N 3243

Илл.19. Графические реконструкции внешнего облика по черепам:
а) № 3343 и б) № 3243
(выполнены А.И. Нечвалодой)

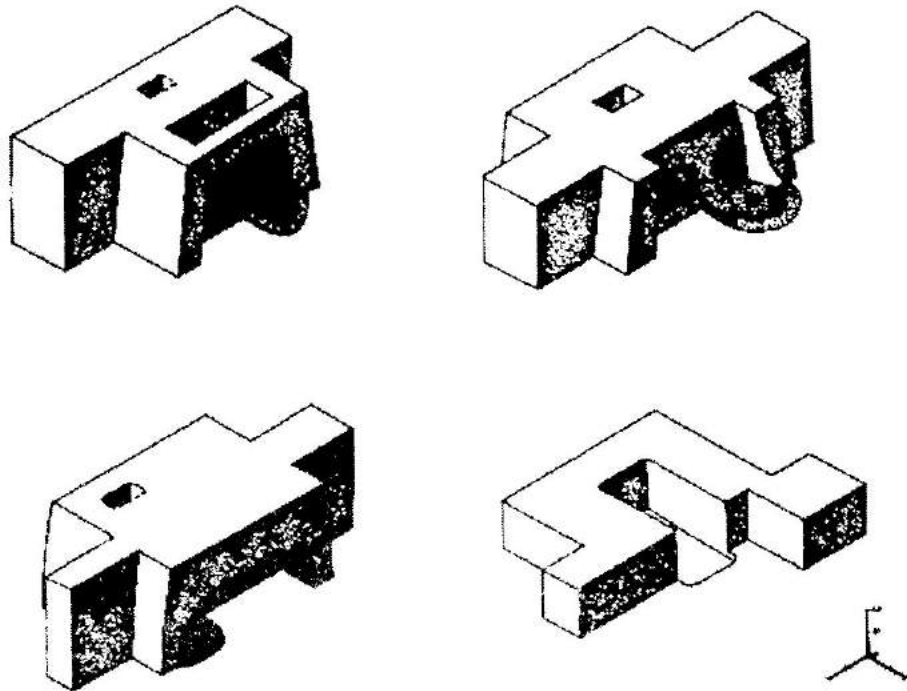

20.
Fig.20.
Илл.20.

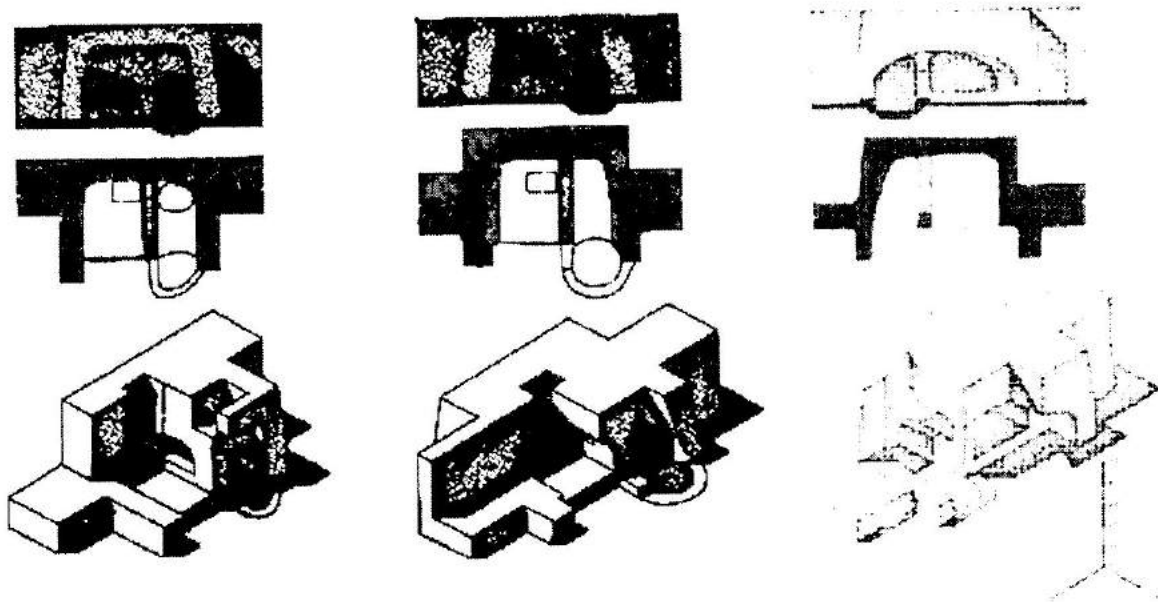

21.
Fig.21.
Илл.21.

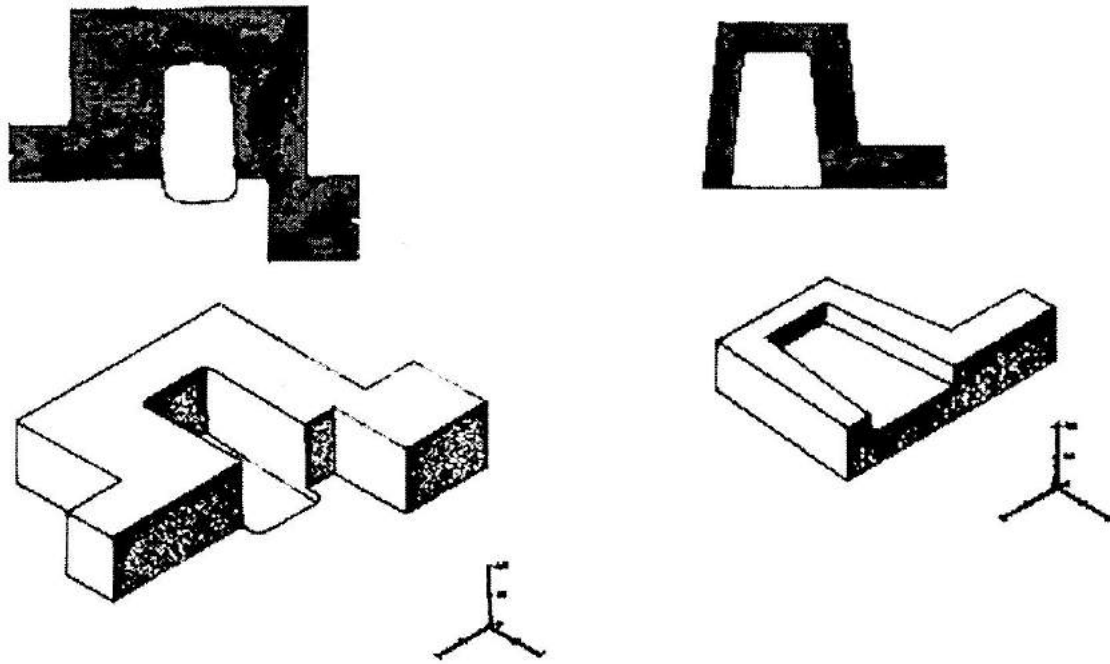

22.
Fig.22.
Илл.22.

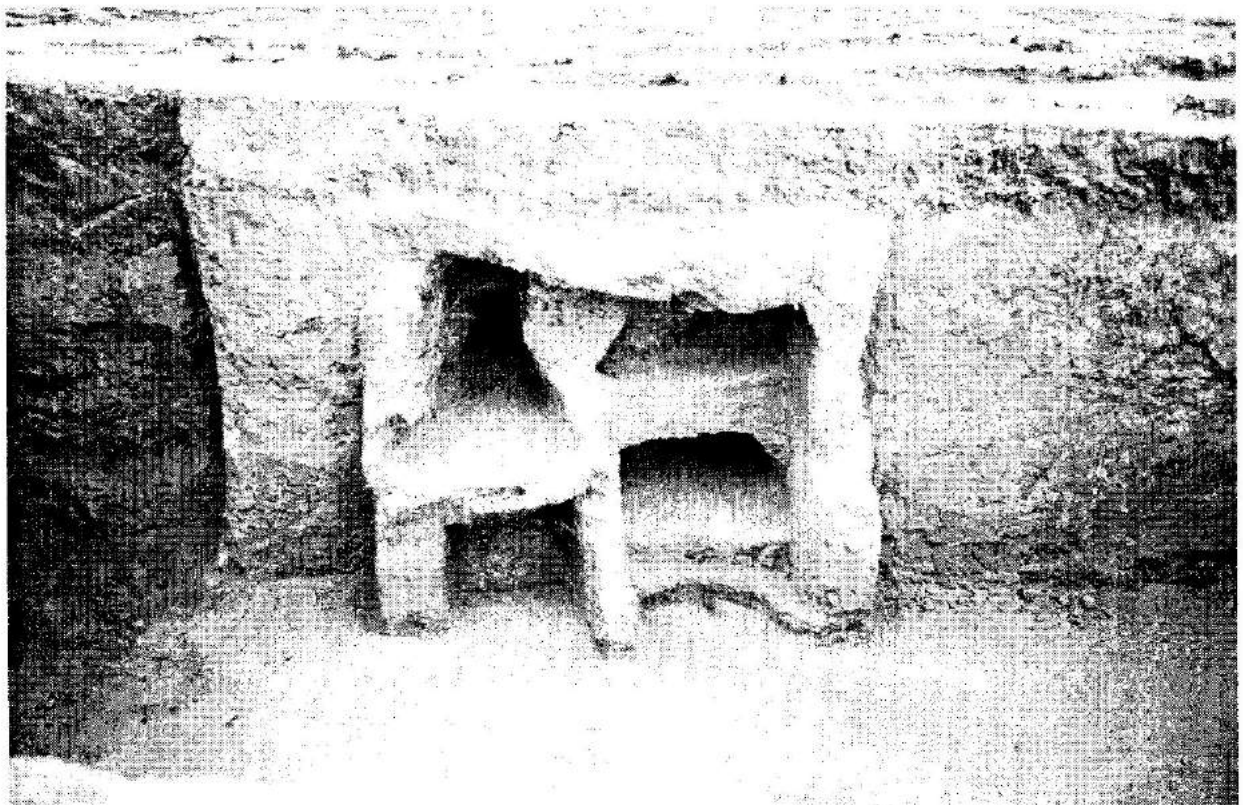

23.
Fig.23.
Илл.23.

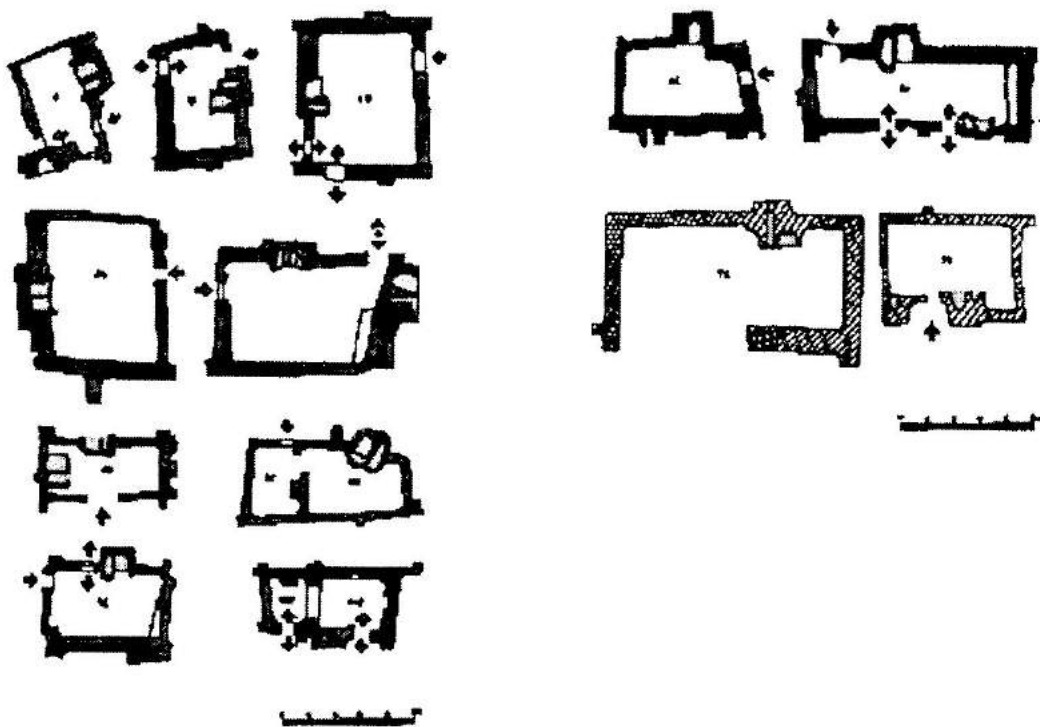

24.
Fig.24.
Илл.24.

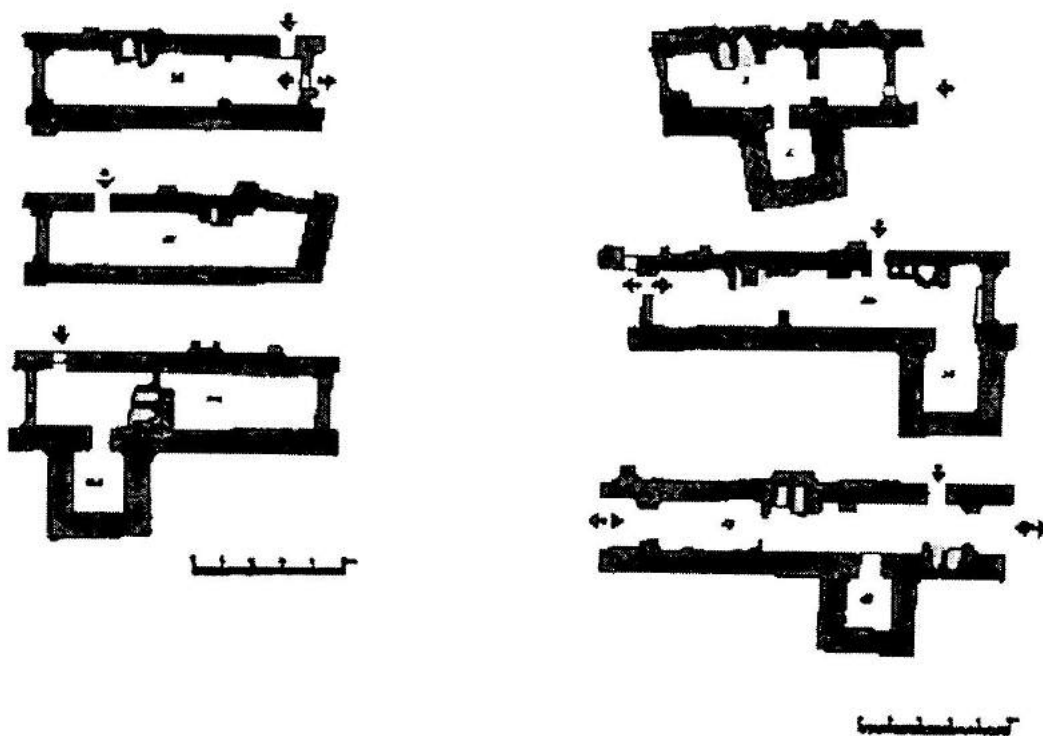

25.
Fig.25.
Илл.25.

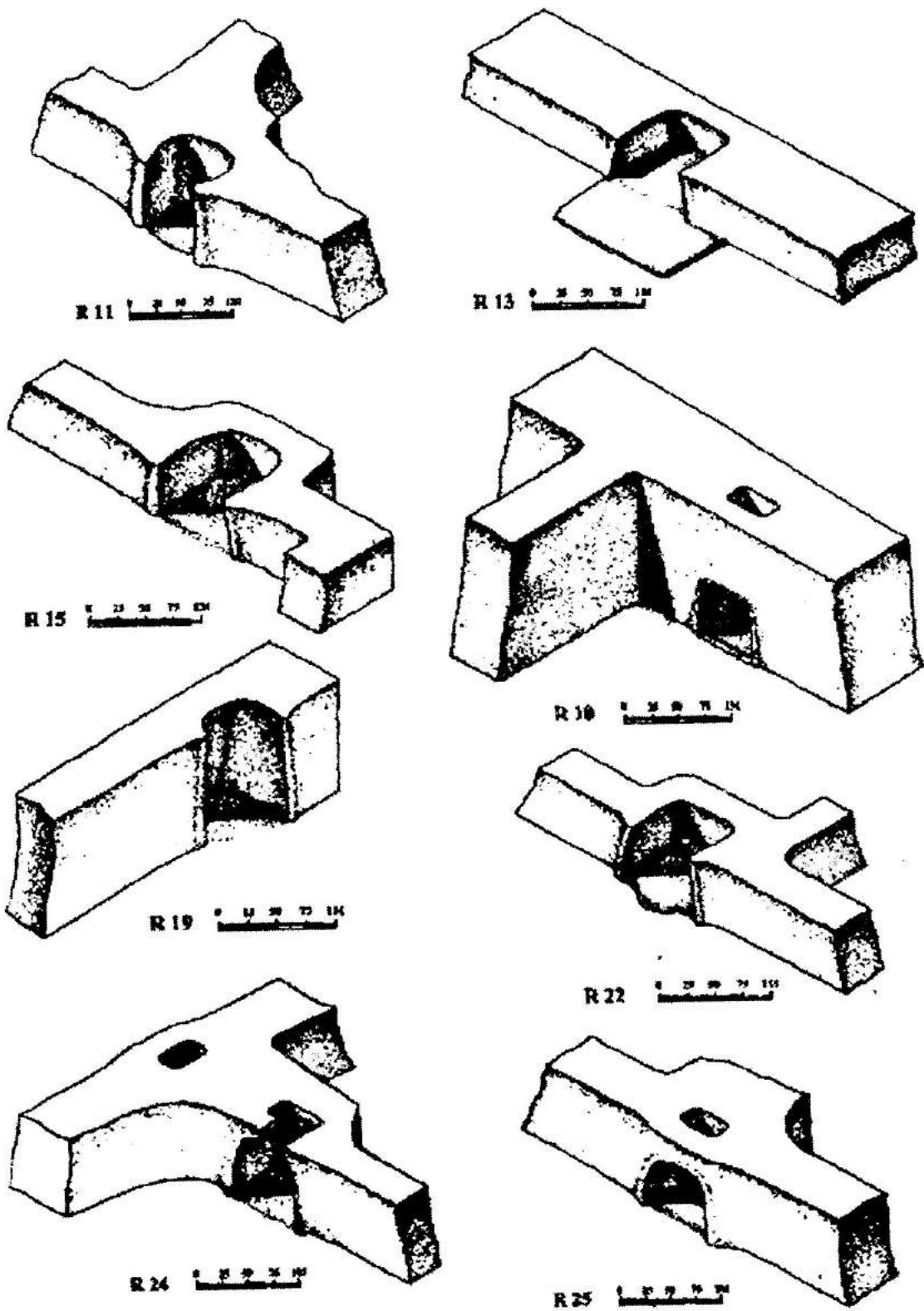

26.
Fig.26.
Илл.26.



27.
Fig.27.
Илл.27.

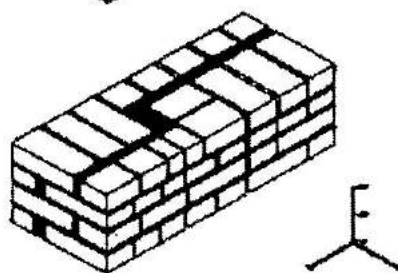
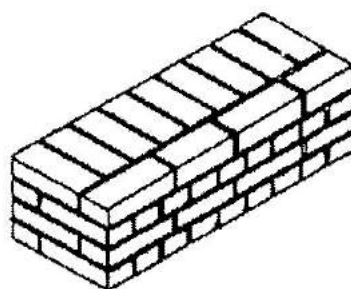
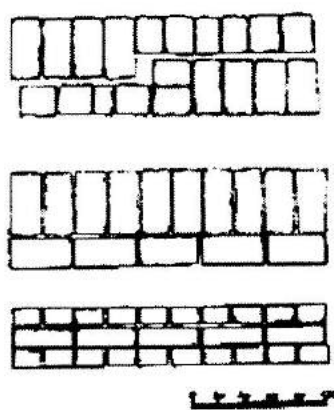
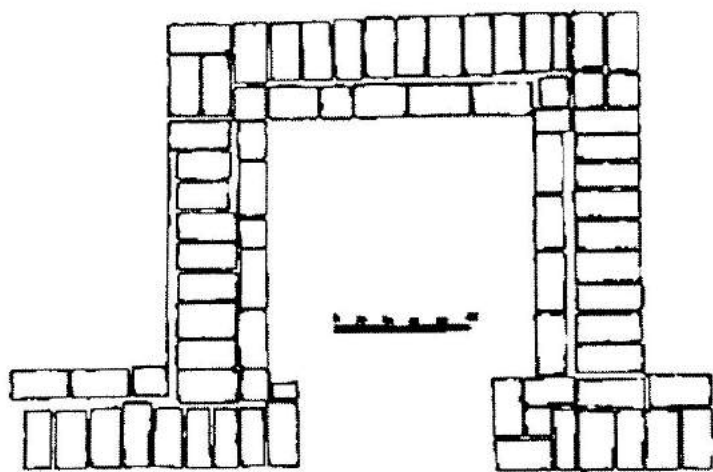

28.
Fig.28.
Илл.28.

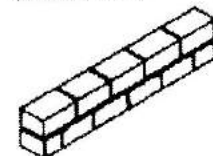
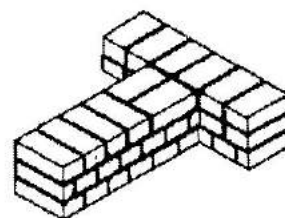
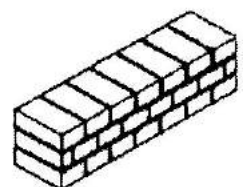
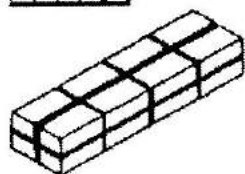
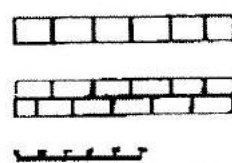
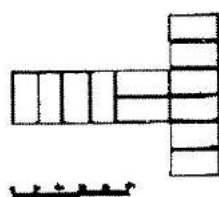
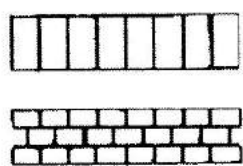
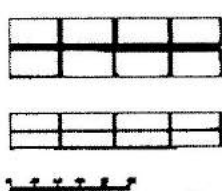

29.
Fig.29.
Илл.29.



30.
Fig.30.
Илл.30.

Damb Sadaat II	
Namazga III	
Damb Sadaat II	
Namazga III	

31.
Fig.31.
Илл.31.

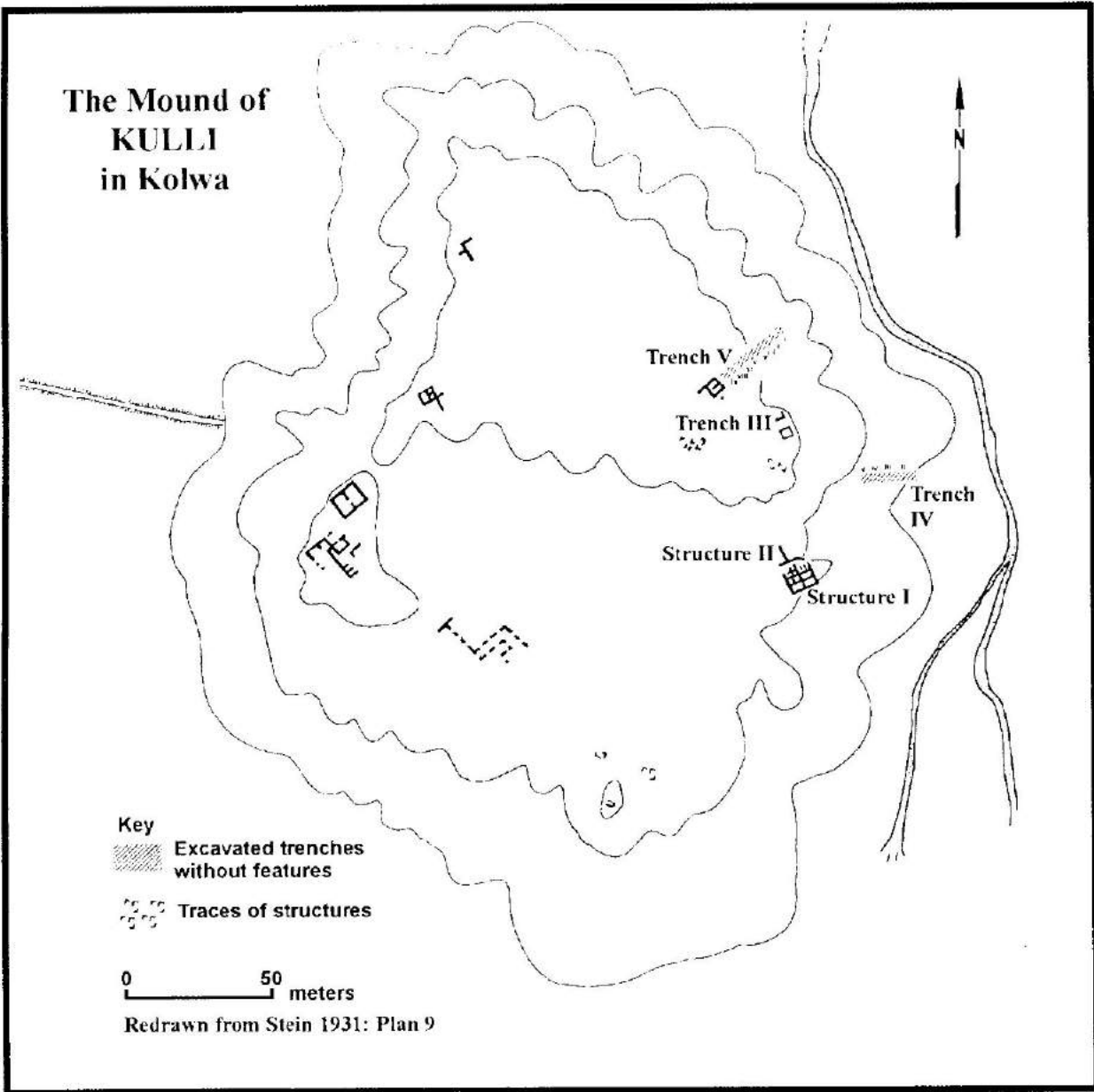

32.
 Fig.32.
 Inn.32.

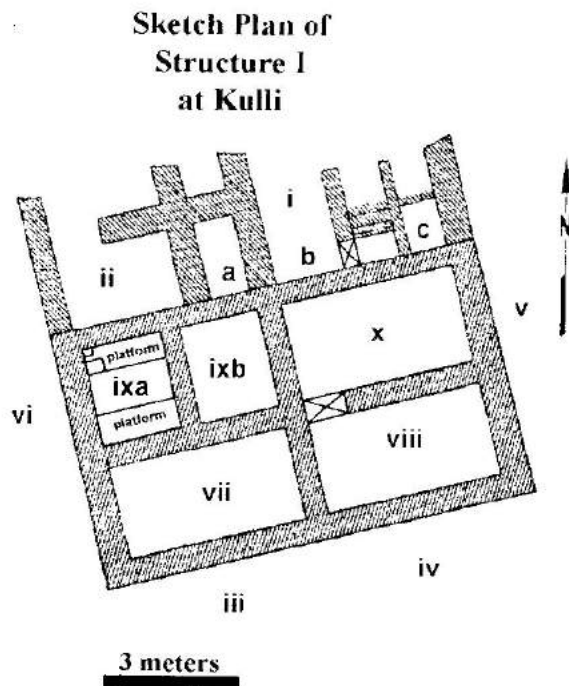

**Sketch of elevation
showing masonry
on wall face v, Structure I
at Kulli**

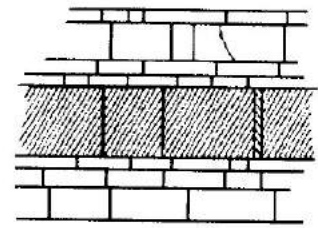

- slabs of shale
- slabs of sandstone
- small stones filling interstices

2 meters

33.
Fig.33.
Илл.33.

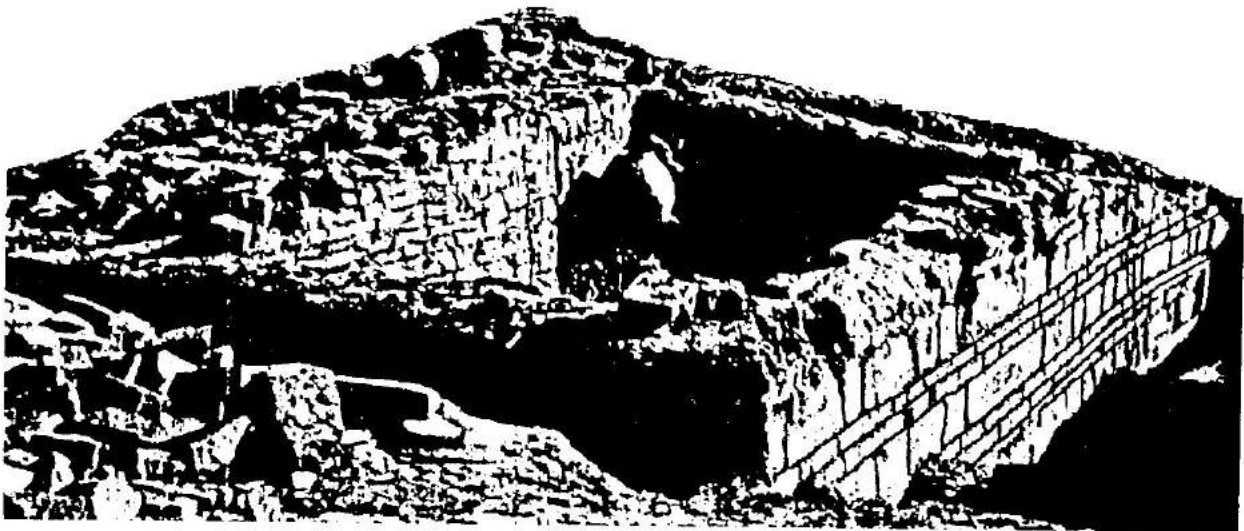

34.
Fig.34.
Илл.34.



35.
Fig.35.
Илл.35.

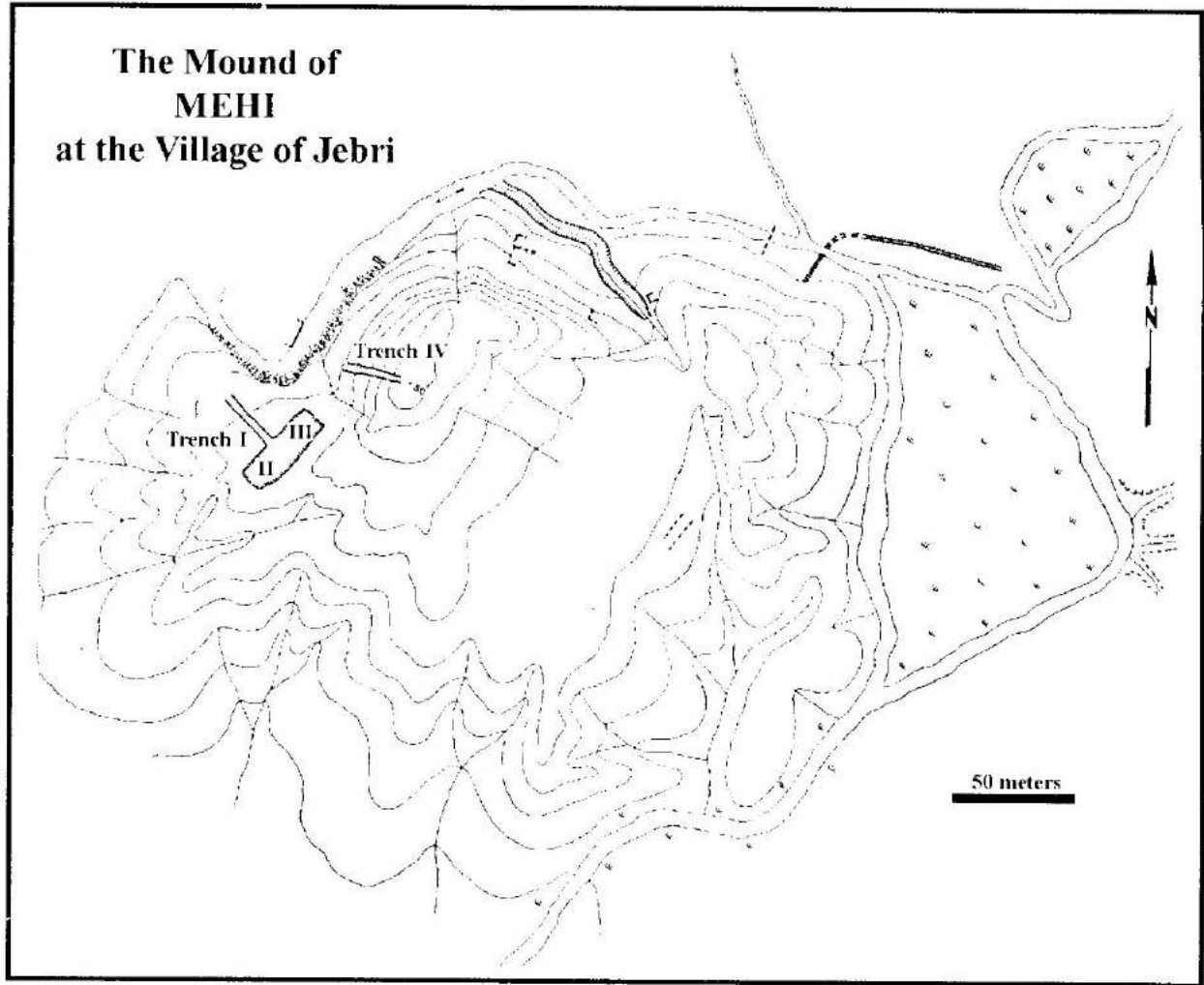

36.
Fig.36.
Илл.36.

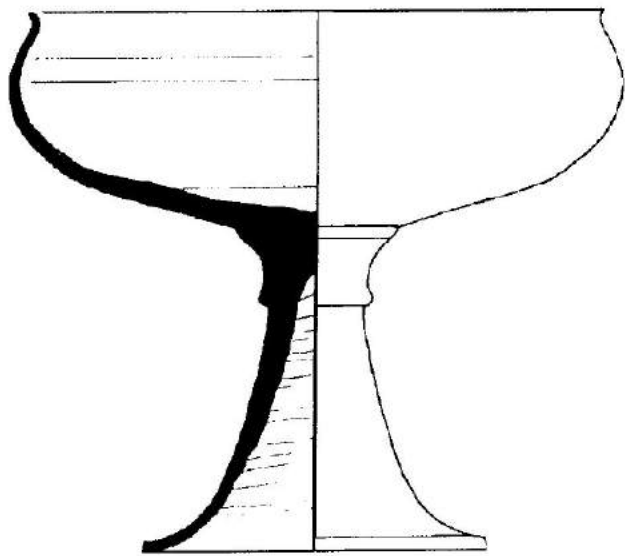

Mehi III.6.13

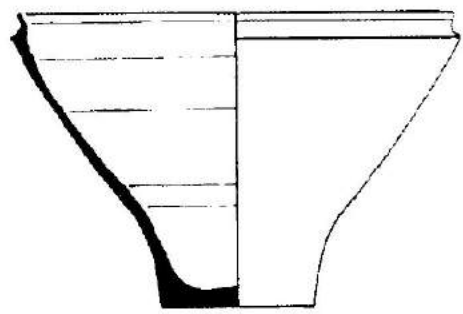

Mehi III.6.2

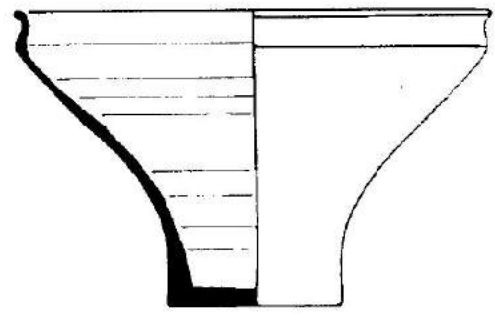

Mehi III.6.3

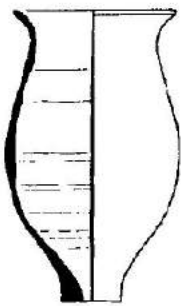

Mehi I.1.2

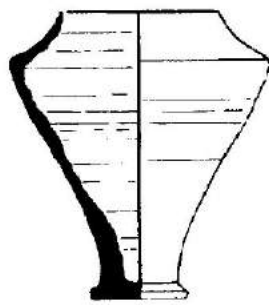

Mehi I.4.2

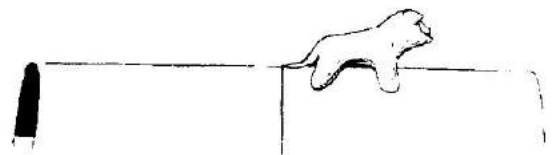

Mehi II.2.7.a

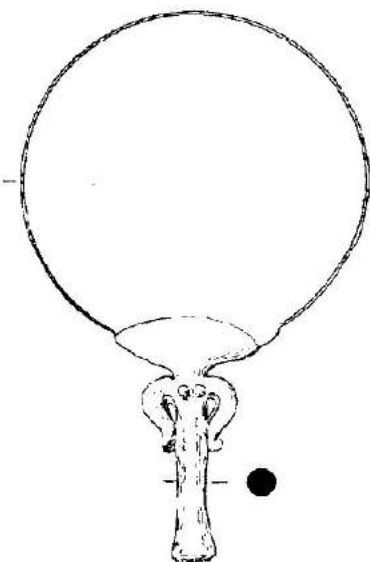

Mehi II.2.1.a

10 cm

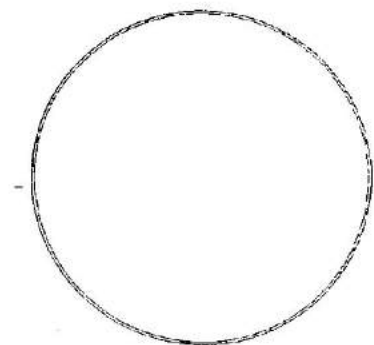

Mehi III.6.5

37.
Fig.37.
Илл.37.

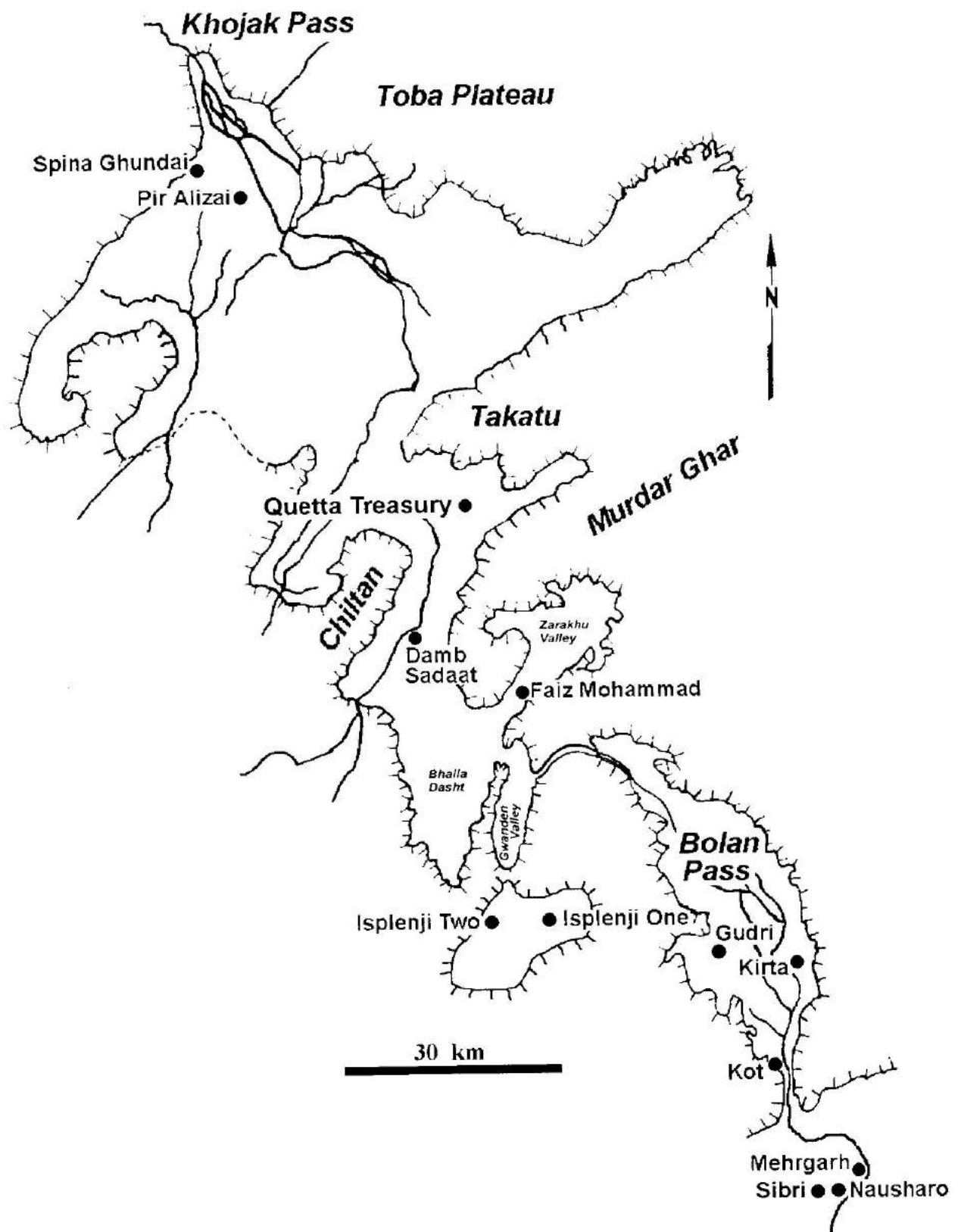

38.
Fig.38.
Илл.38.



39.
Fig.39.
Илл.39.

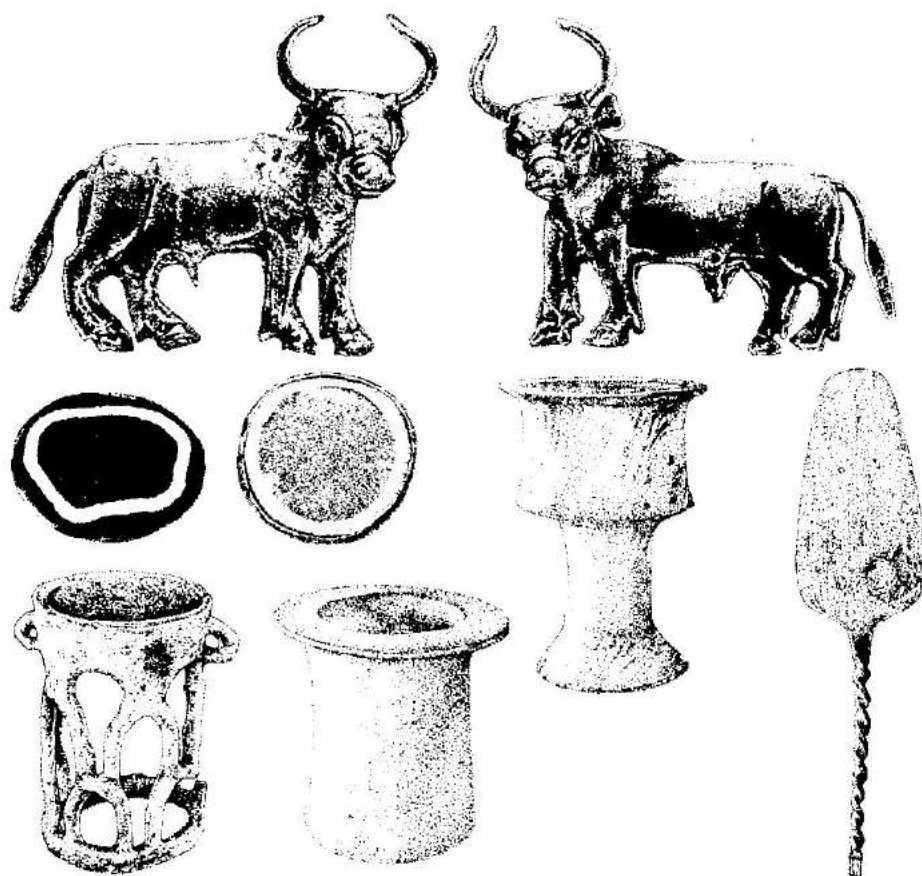

40.
Fig.40.
Илл.40.

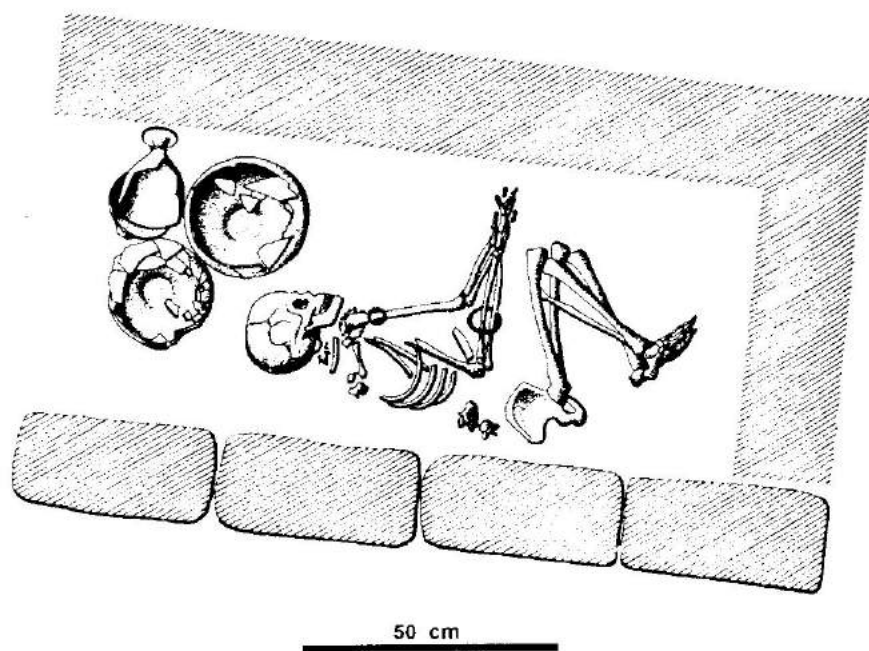

41.
Fig.41.
Илл.41.

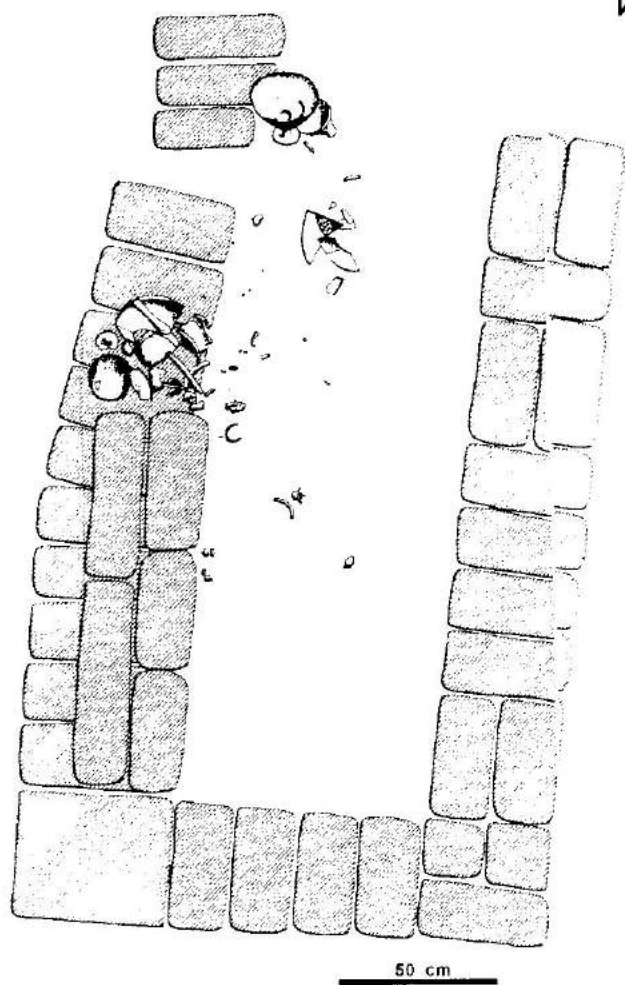

42.
Fig.42.
Илл.42.

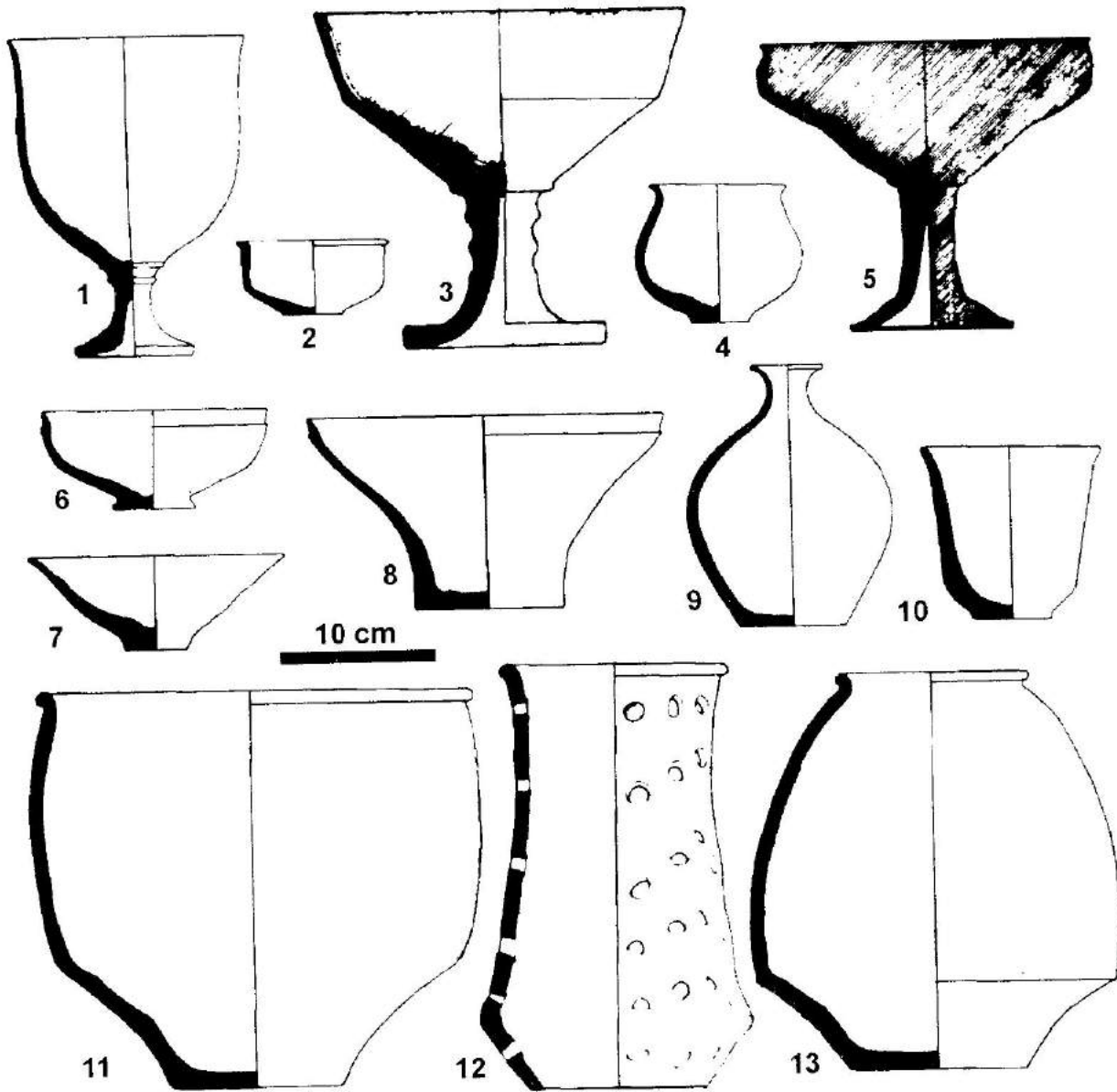

43.
 Fig.43.
 Илл.43.

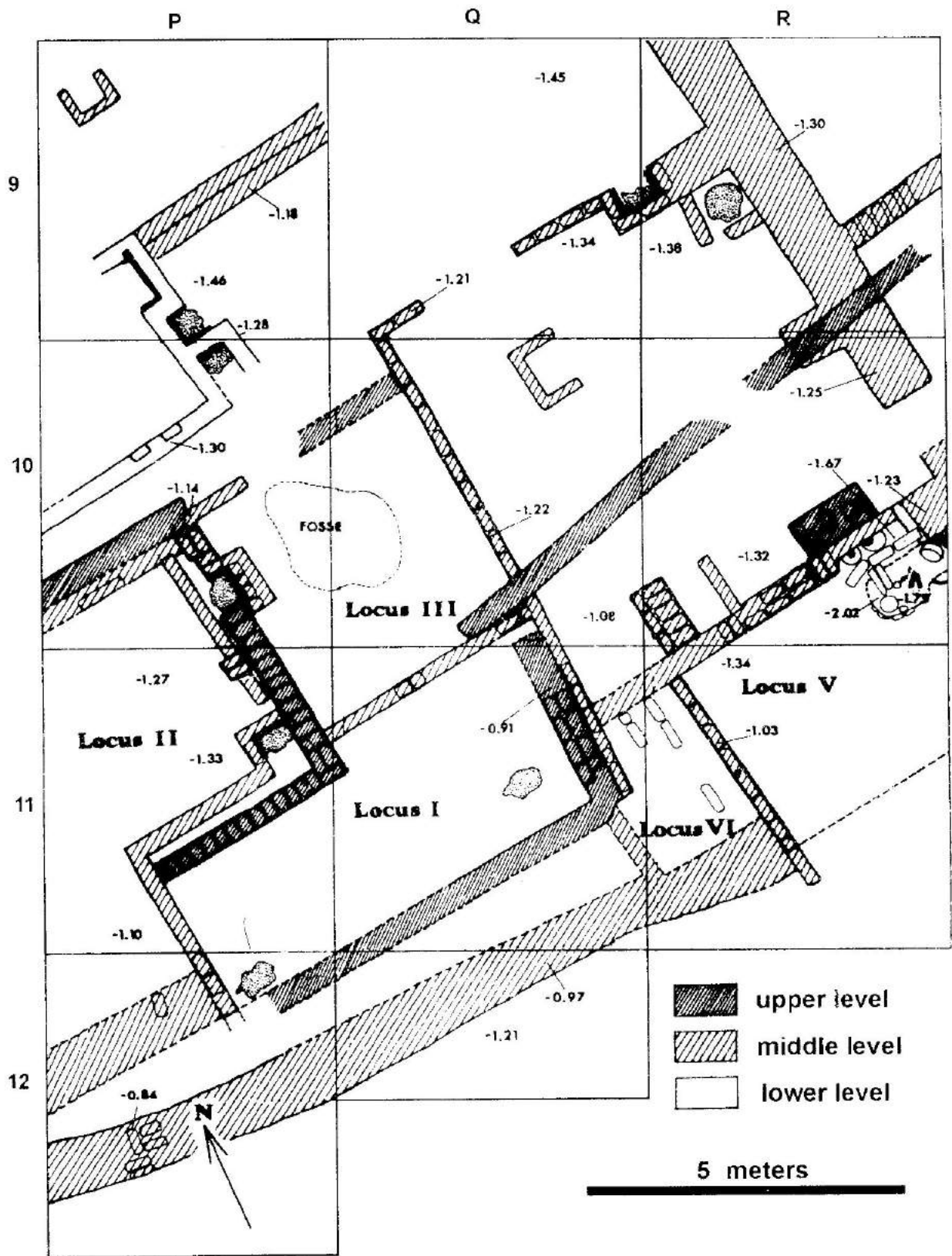

44.
Fig.44.
Илл.44.

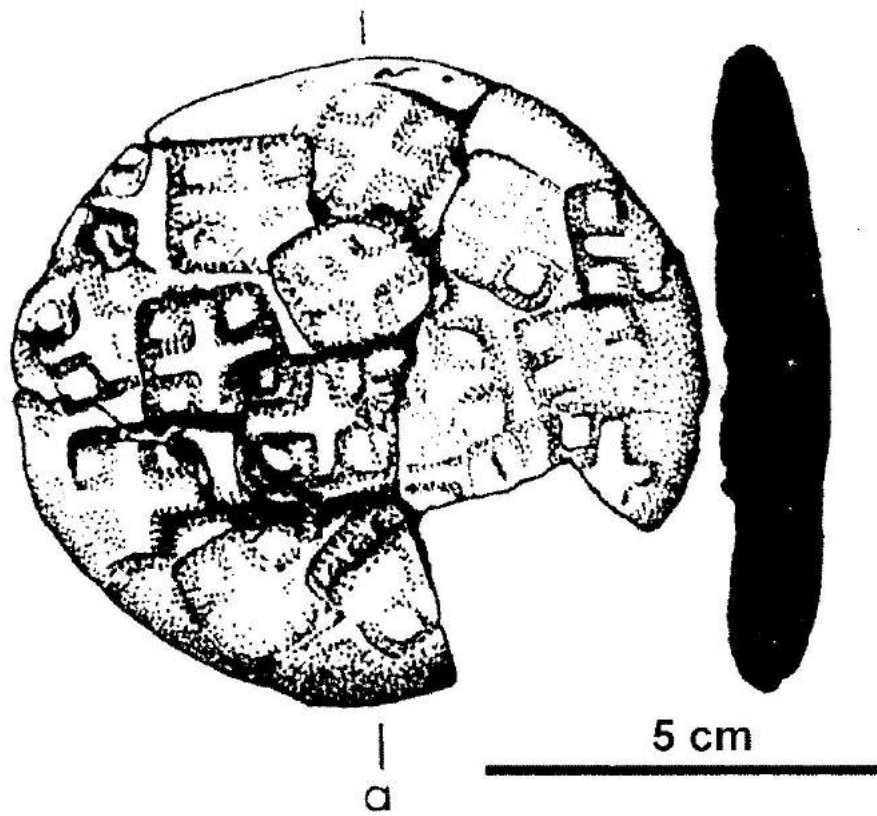

45.
Fig.45.
Илл.45.

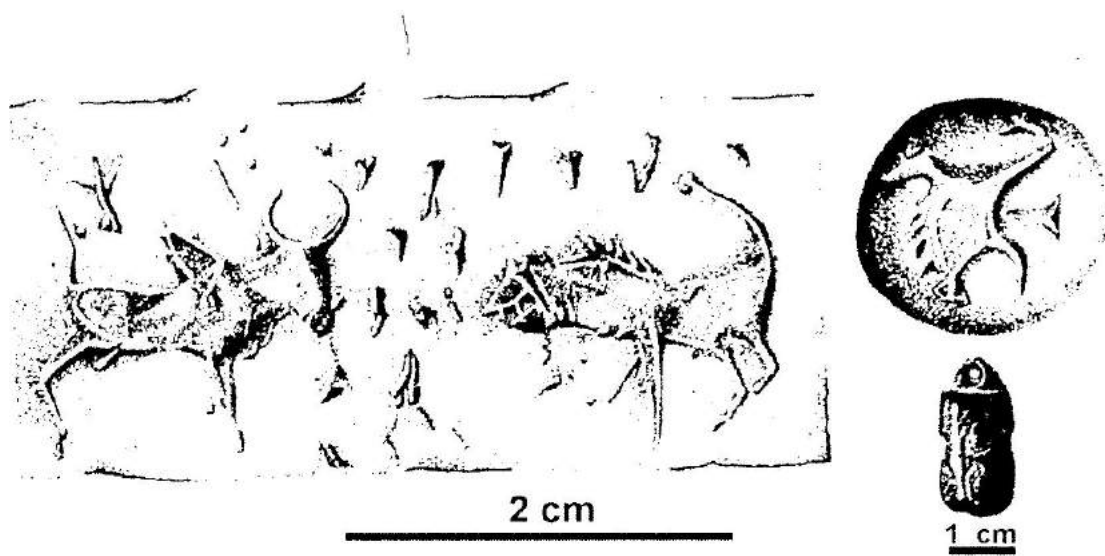

46.
Fig.46.
Илл.46.



Design on the base
of the cylinder seal

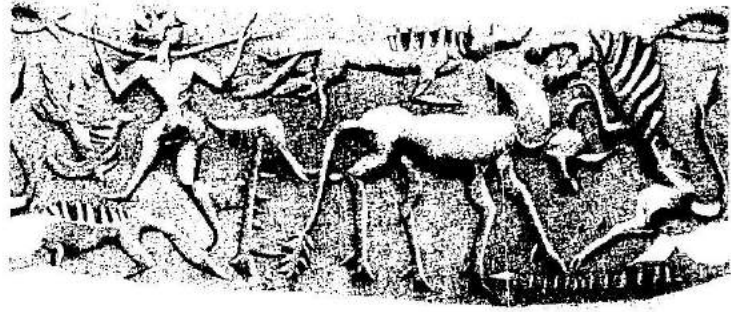

1 cm

47.
Fig.47.
Илл.47.



48.
Fig.48.
Илл.48

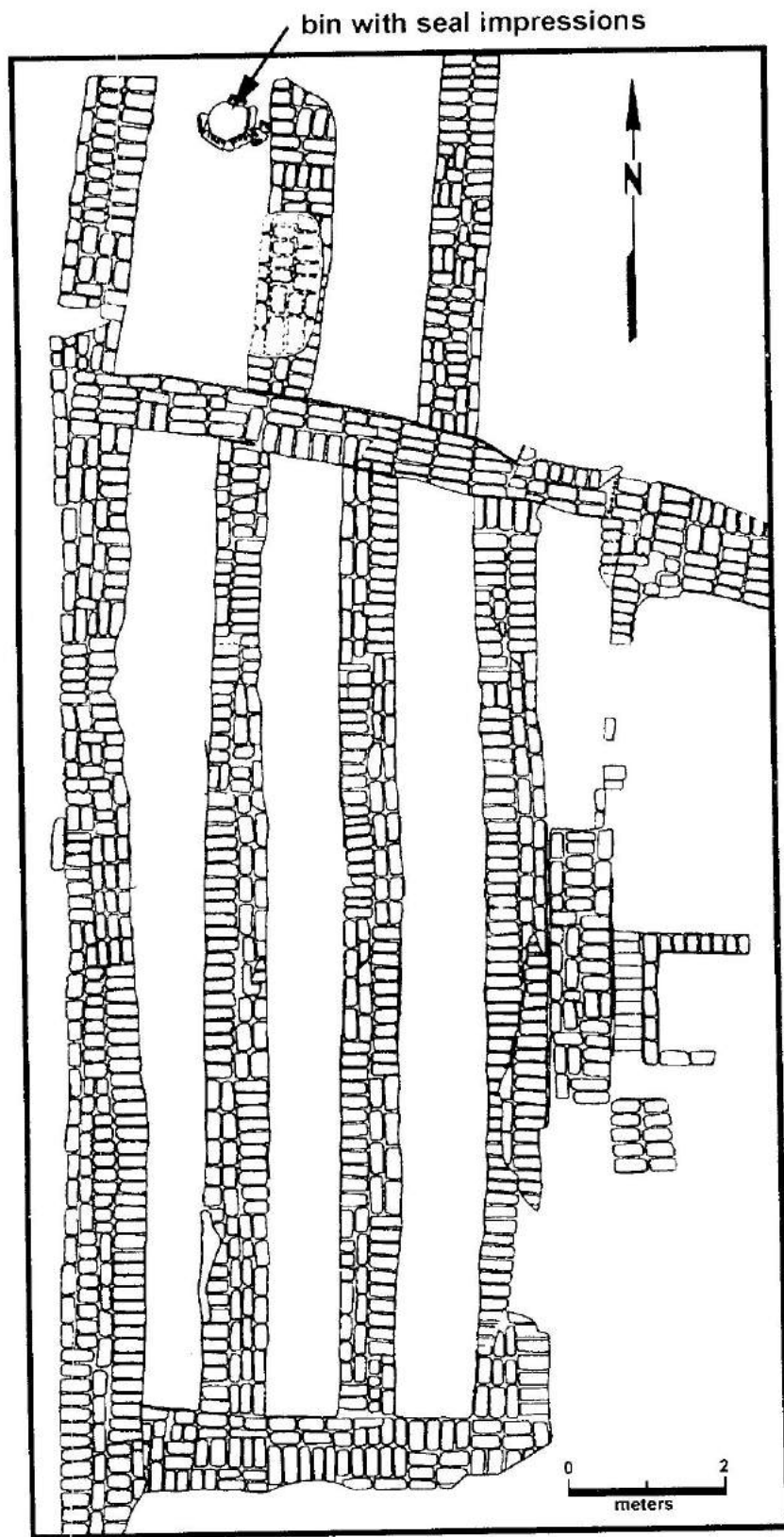

49.
Fig.49.
Мнн.49.



50.
Fig.50.
Илл.50.

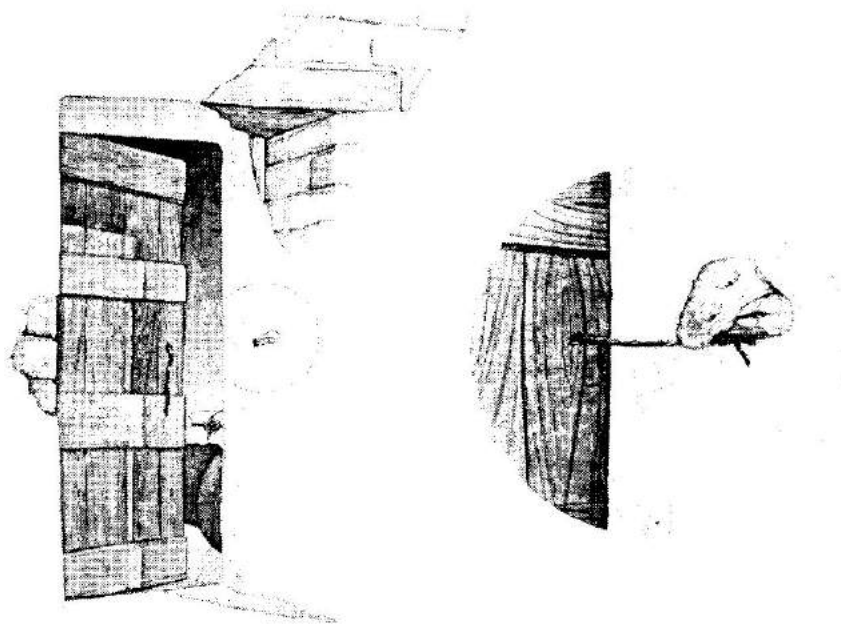

51.
Fig.51.
Илл.51.

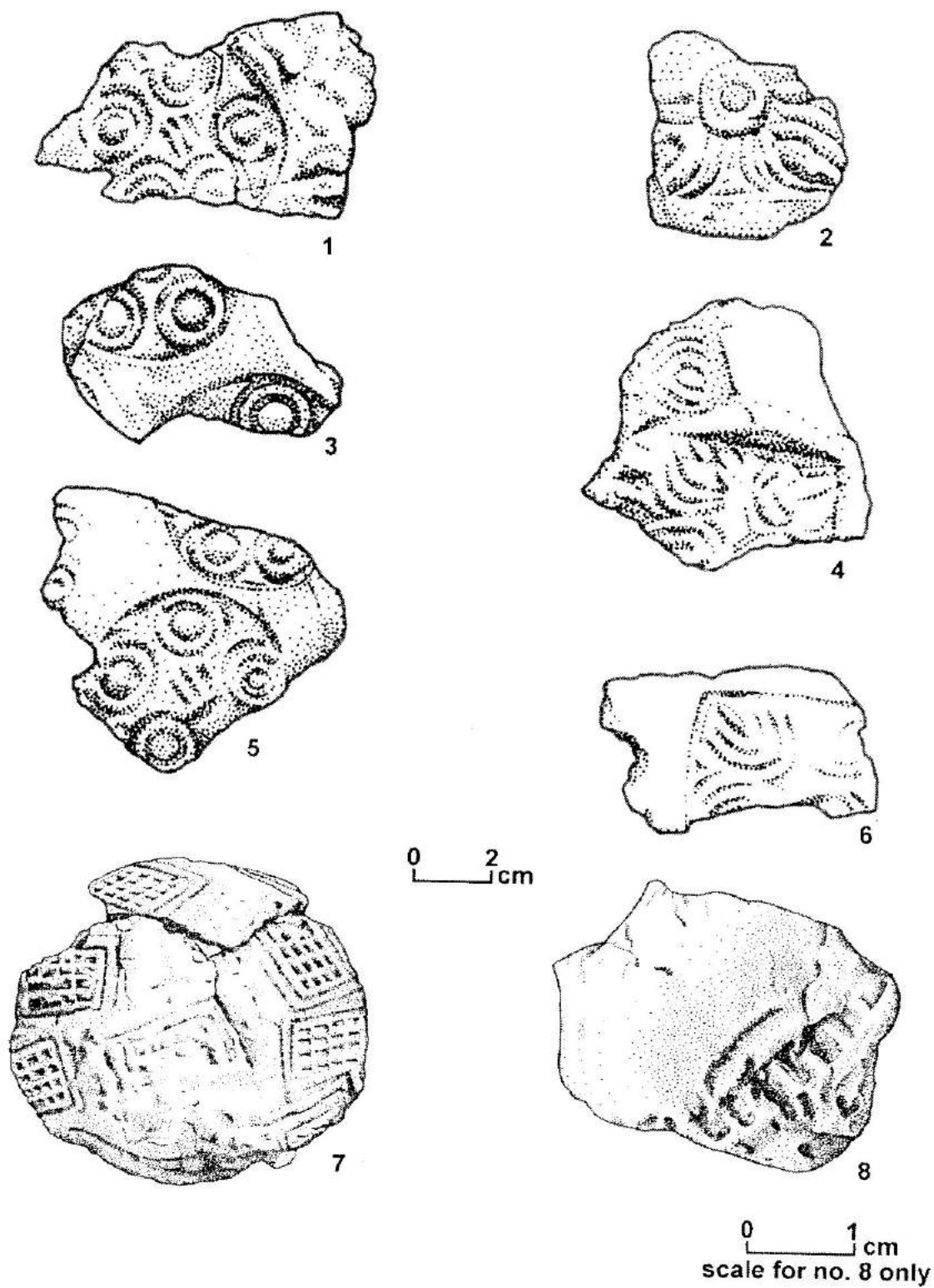

52.
 Fig.52.
 Илл.52.

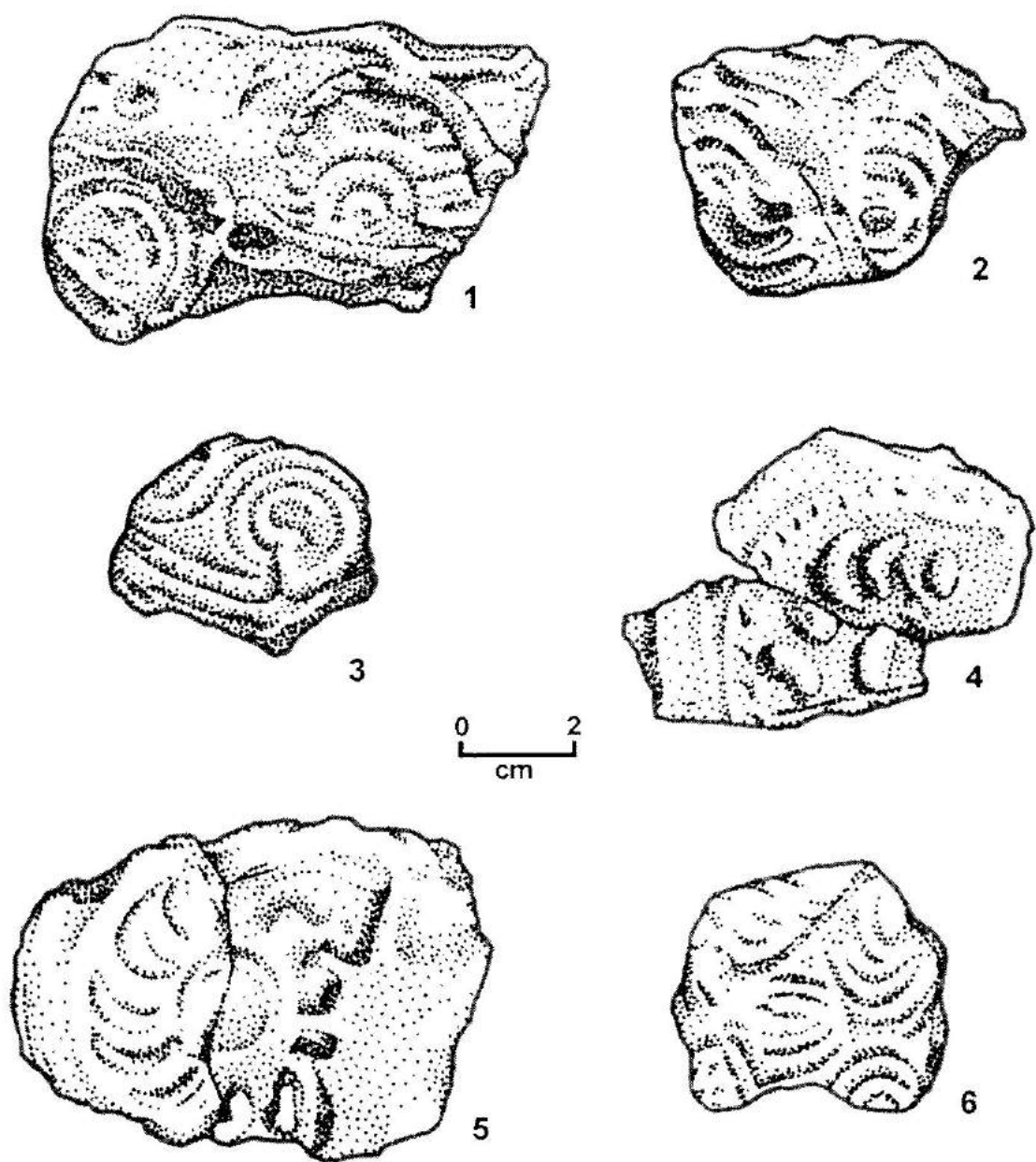

53.
Fig.53.
Илл.53.

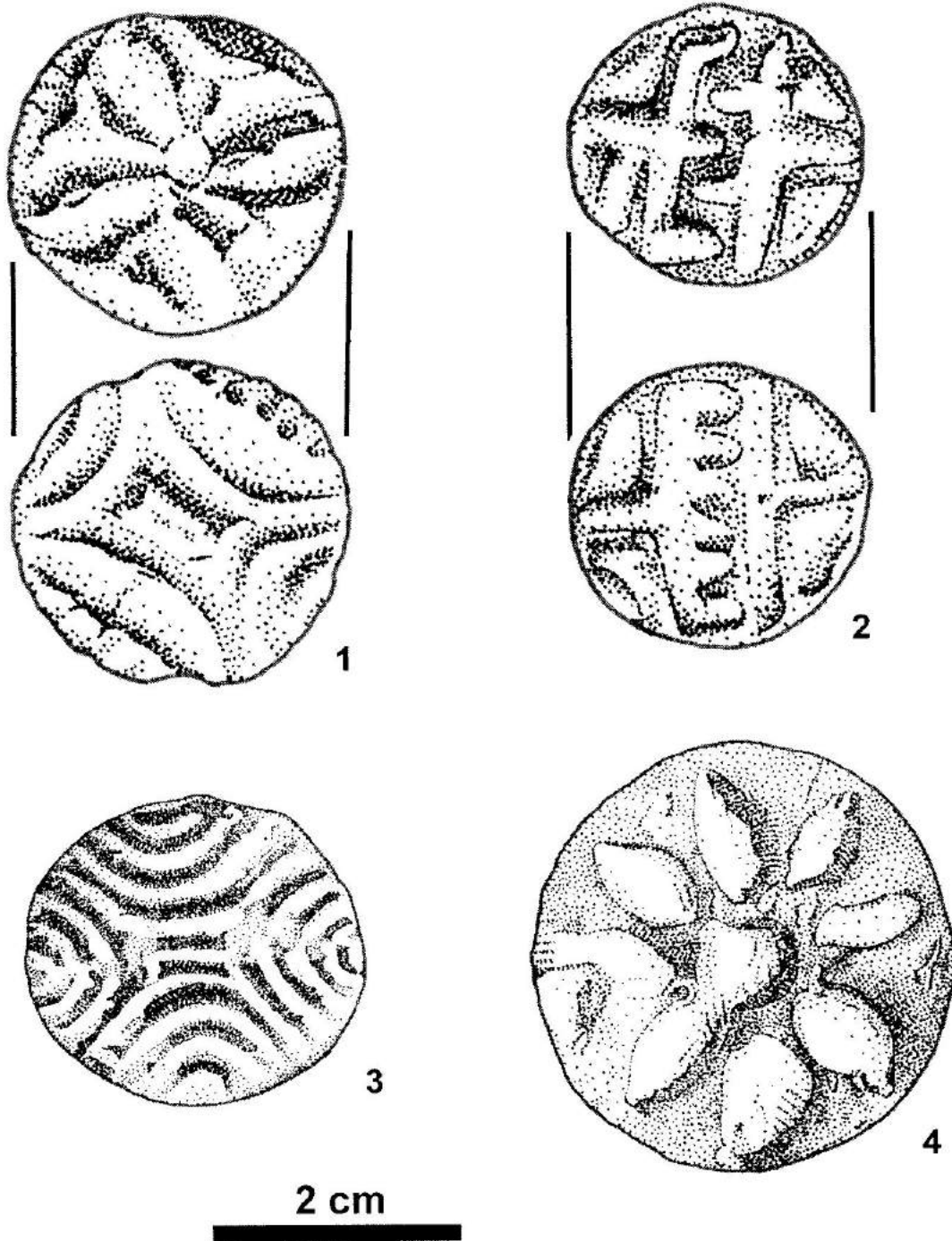

54.
Fig.54.
Илл.54.

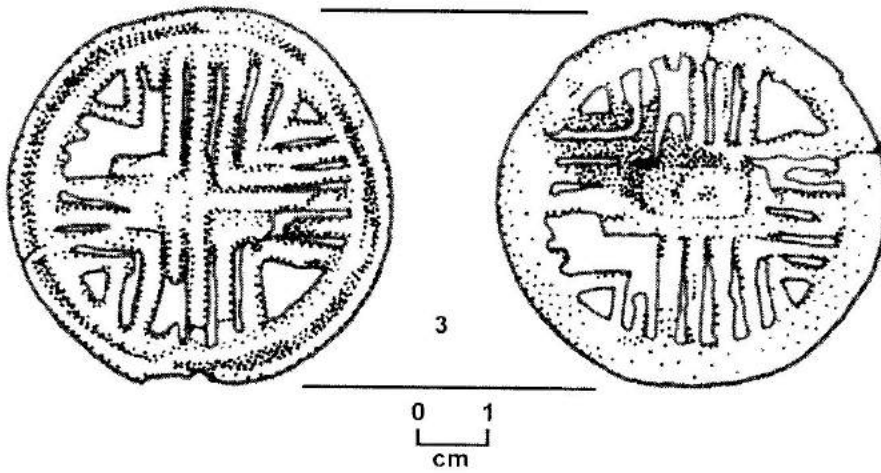
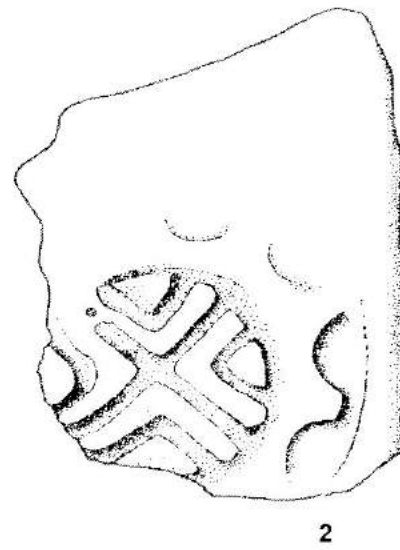
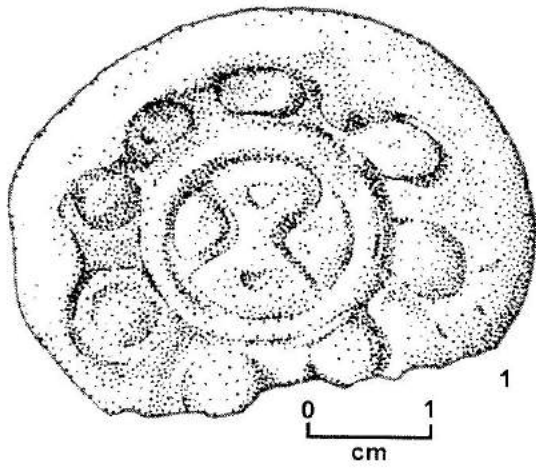

55.
Fig. 55.
Илл. 55.

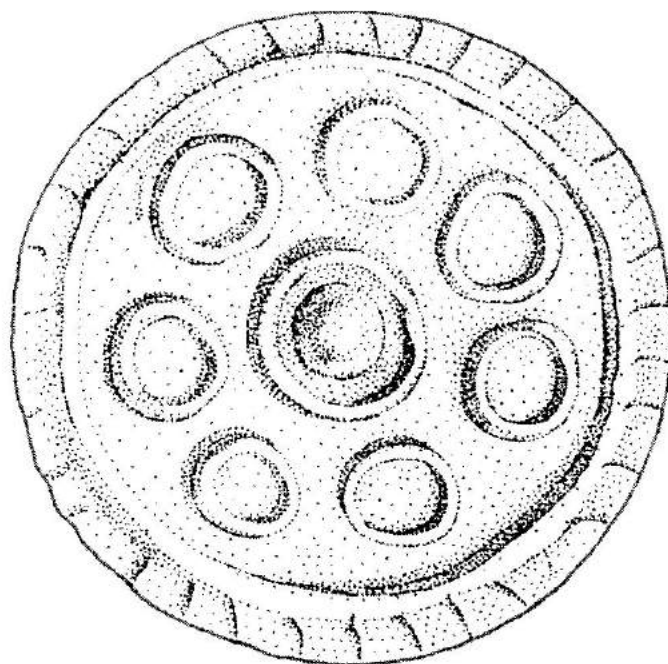

2 cm

Nindowari

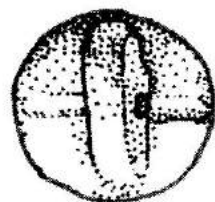

2 cm

Kot Diji

56.
Fig.56.
Илл.56.

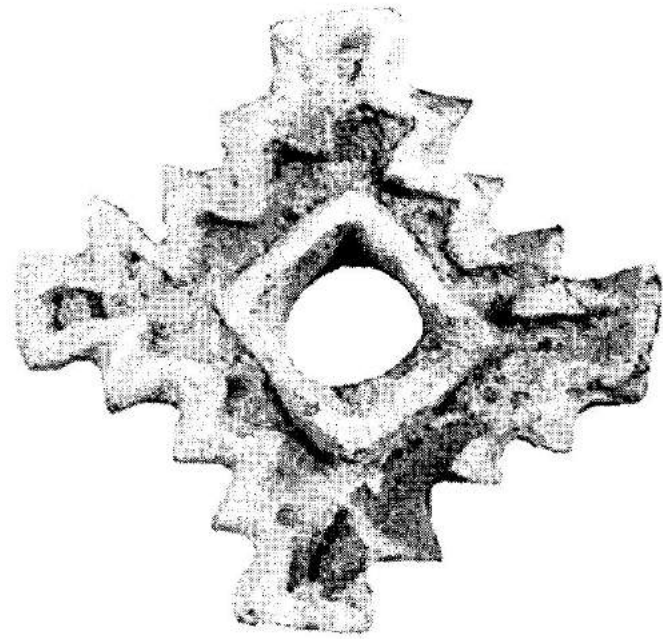

2 cm

57.
Fig.57.
Илл.57.

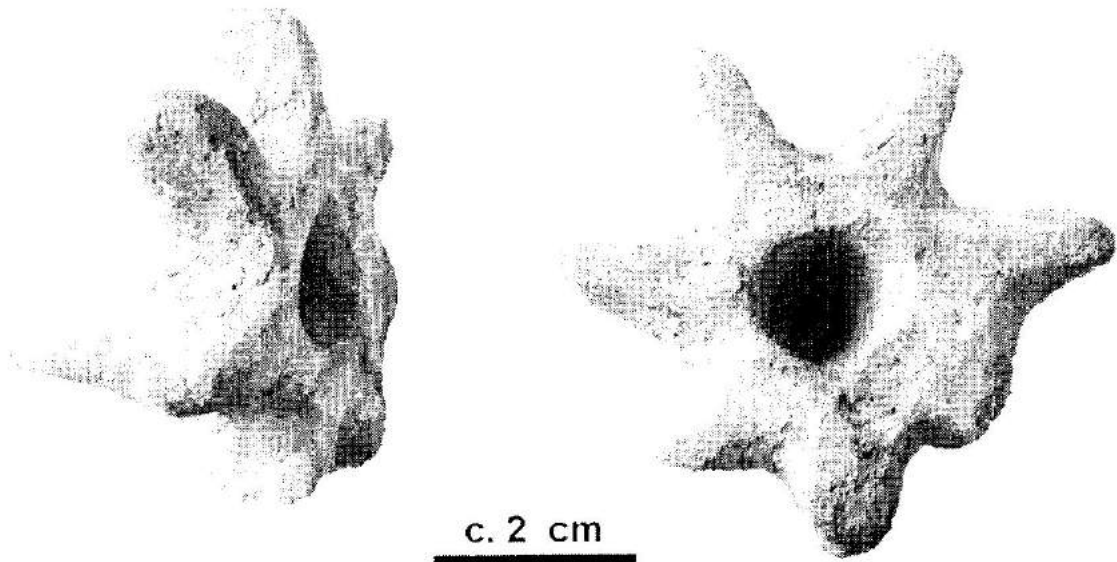

с. 2 cm

58.
Fig.58.
Илл.58.

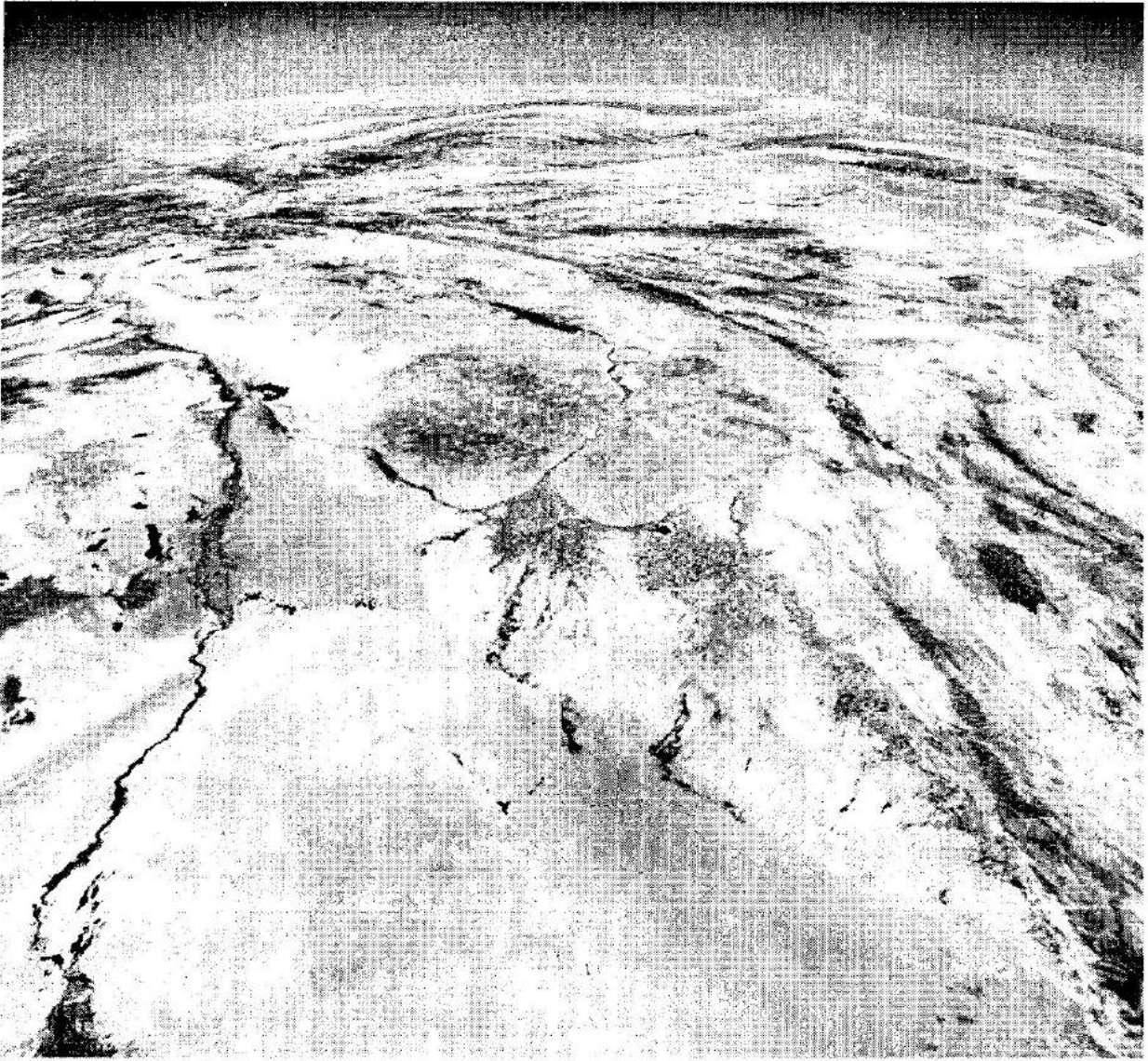
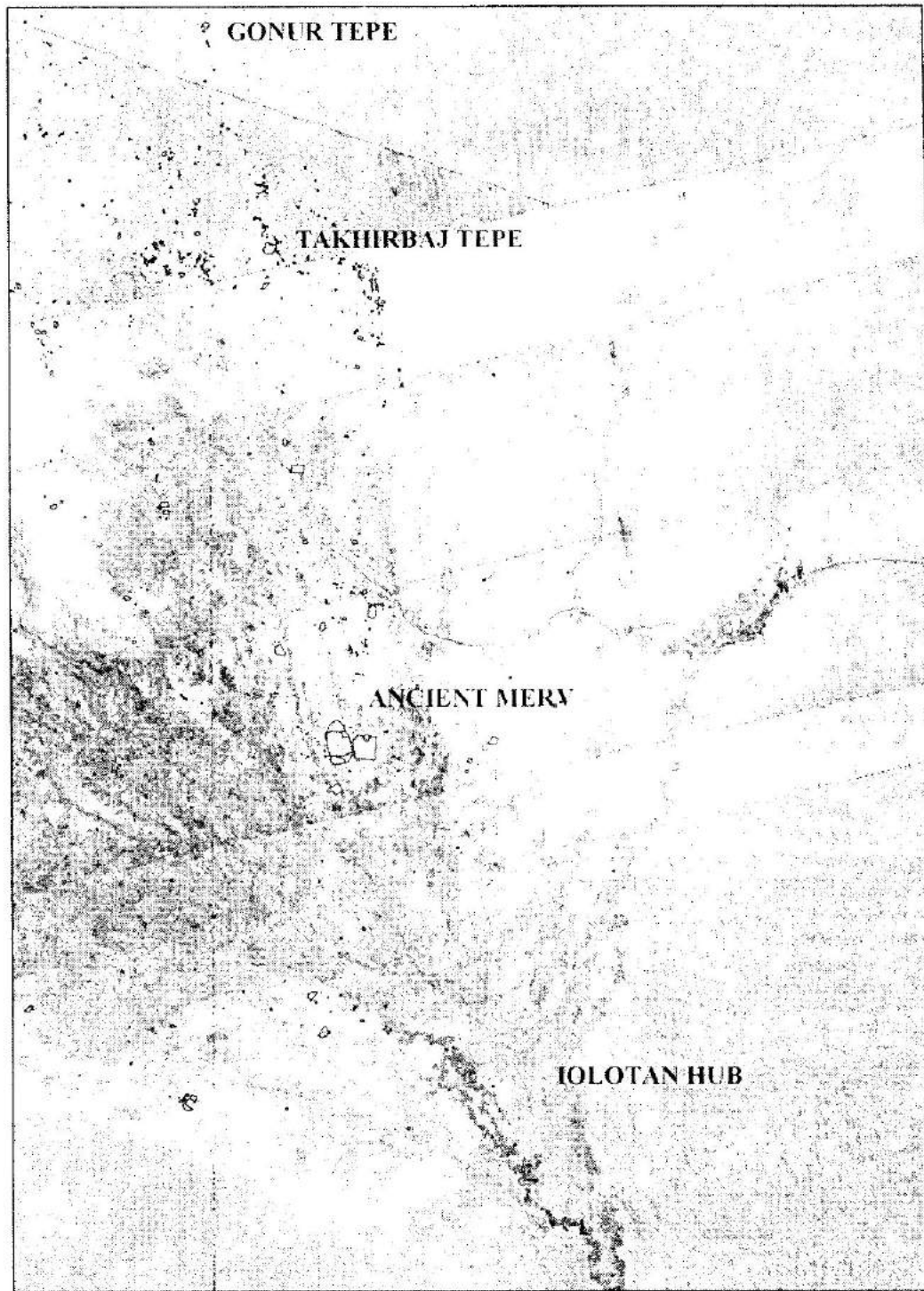

Fig.59. View of northern Turkmenistan (by Google EarthSat).



0 5 10 20 30 40 Kilometers



Fig. 60. Distribution of archaeological sites along the main palaeochannels on the basis of Corona overlapped on SRTM imagery.



Fig. 61. Distribution of Middle Bronze Age sites.

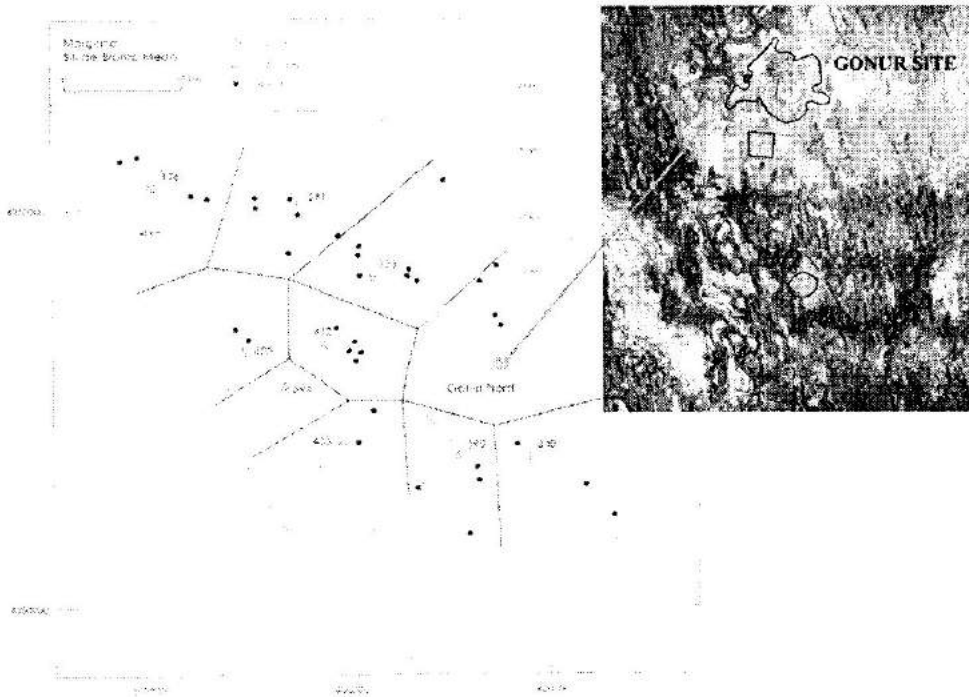

Fig. 62. Thiessen polygons analysis of Middle Bronze Age settlements (by Sandro Salvatori) and the ancient irrigation system of Gonur site.

MAZMUNY

«Gadymy Margiana dünýä siwilizasiýasynyň täze merkezidir» atly halkara ylmy maslahata gatnaşyjylara	11
--	----

W.I.SARIANIDI (Russiýa — Türkmenistan) TÜRKMENISTAN — GADYMY GÜNDOGAR SIWILIZASIÝASYNYŇ MERKEZI AZIÝA OJAGY	15
--	----

YLMY NUTUKLAR

B.ÇERAZETTI (Italiýa) MURGABYŇ GADYMY AKABASY BÜRÜNÇ EÝYAMYŇDA	31
N.A.DUBOWA (Russiýa) ANTROPOLOGIÝA MAGLUMATLARY ESASYŇDA GOŇURDEPÄNIŇ ILATY BARADA	32
A.-P. FRANKFORT (Fransiýa) OKS SIWILIZASIÝASY WE B.E. ÖŇKI 2300–1800-nji ÝYLLARDA MARŞAHI ÝURDUNYŇ ÝERLEŞEN ÝERI BARADAKY MESELELER DOGRUSYŇDA	34
Ž.FUSMAN (Fransiýa) MARGUŞ WE MERKEZI AZIÝA HALKLARY	35
D.S.HARAKWAL (Hindistan), T.OSADA (Ýaponiýa) BAKTRIÝA-MARGIANA ARHEOLOGIÝA TOPLUMY; AHAR MEDENI TOPLUMY	36
W.KRÝUKOWA (Russiýa) MARGUŞ ÝURDUNYŇ HAKYKY KEŞBI WE MERKEZI AZIÝA HALKLARYNYŇ MEDENI DÄPLERI	37
E.E.KUZMINA (Russiýa) GIÇKI BÜRÜNÇ ZAMANYNA DEGIŞLI MARGIANA WE BAKTRIÝA MEDENIÝETI	37
J.MALLORI (ABŞ) GOŇUR DEPEDÄKI MAZARYSTANLYK: JEMGYÝETÇILIK GURLUŞYNYŇ HASABAT JÄHTDEN AÝRATYNLYKLARY	38
M.MÄMMEDOW (Türkmenistan) GADYMY MARGIANANYŇ BINAGÄRLIGI	39
ANNAMYRAT ORAZOW (Türkmenistan) AJYGUYÝ JULGESINIŇ OJAKLARY	40
B.N.ÖDEMYRADOW (Russiýa) MARGIANADAKY BARLAGLARYŇ KÄBIR JEMLENEN NETIJELERI	44
A.PARPOLA (Finlýandiýa) ARYÝ MESELESİ WE BAKTRIÝA–MARGIANA ARHEOLOGIÝA TOPLUMY	45

G.L.POSSEL (ABŞ) BAKTRIYA–MARGIANA ARHEOLOGIYA TOPLUMY WE BEYIK HIND JÜLGESI	46
K.RENFRÝU (Beýik Britaniya) MARGIANA WE TÖWEREGINI GURŞAN DÜNYÄ TOPARLAÝYN JEMGYÝET: EGEÝ KYBAPDAŞLYGY	46
H.ÝUSUPOW (Türkmenistan) TÜRKMENISTANYŇ GADYMY MALDARLARYNYŇ DINI YGTYKATLARY	47

GYSGA HABARLAR

Hassan Akbari, Morteza Hessari (Eýran) BIZIŇ EÝÝAMYMYZDAN OZALKY III MÜŇÝLLYKDAKY ÖZARA MEDENI GATNAŞYKLARYŇ SUBUTNAMALARY DOGRUSYNDA	49
Annadursun Ataýewa (Türkmenistan) GADYMY MARGIANANYŇ EKERANÇYLYK TARYHY BARADA	50
Gunça Ataýewa (Türkmenistan) ATA-BABALARYMYZYŇ DINI YNANÇLARY	51
Oraz Babakow (Türkmenistan) AJYGUÝY-1 ÝADYGÄRLIGINDEN TAPYLAN ENEOLIT ZAMANYNYŇ KELLEÇANAGY	52
Agamyrat Baltayew (Türkmenistan) TÜRKMENISTANDA ZENAN HUDAÝYNA ÇOKUNMAK BILEN BAGLY RUHY MIRASYŇ ETNOGRAFIKI YZLARY	53
Nurgözel Başimowa (Türkmenistan) GADYMY MARGIANANYŇ OGUZ HAN TÜRKMEN EÝÝAMYNDAKY MEDENI GATNAŞYKLARY	54
Frederik Brüne (Fransiya) MERKEZI AZIYA B.E.ÖŇKI III MÜŇÝLLYKDA: AKJADERÝANYŇ, MARGIANANYŇ WE SEÝISTANYŇ ARASYNDAKY BAGLANÝŞYKLAR	55
Annageldi Gubaýew, Täçmuhammet Sahydow (Türkmenistan) “ZARATUSTRANYŇ WASP EDEN ÝERLERI”	56
Jepbarguly Hatamow, Jumamyrat Gurbangeldiýew (Türkmenistan) MARGUŞ WE HARAPPA SIWILIZASIÝALARY: MEDENI ARABAGLANÝŞYKLARYŇ TARYHY KÖKLERI	57
Frederik Hibert (ABŞ) BÜRÜNÇ ASYRYNYŇ GADYMY ILATLY MESGENI BOLAN GOŇURDEPÄNIŇ SUWARYMLY JÜLGEDÄKI ŞERTLERINIŇ ÖZBOLUŞLY AÝRATYNLYKLARY	58
Manabu Koiso (Ýaponiya) HIND MÖHÜRLERI WE OŇA KYBAPDAŞ MÖHÜRLERIŇ ÝÜZE ÇYKMAGY BILEN BAGLANÝŞYKLY MESELELER	59

Gurbanjemał Kurayewa (Türkmenistan) GADYMY MARGIANANYŇ ÇEPERÇILIK MEDENIÝETI	60
Ejegül Myradowa (Türkmenistan) GOŇURDEPEDÄKI KÖŞKLER TOPLUMYNYŇ ÝANYNDAKY GADYMY MAZARYSTANLYK	60
Myratgeldi Söýegow (Türkmenistan) TÜRKMEN HALKYNYŇ GADYMY DÜNYÄGARAYŞYNY ÖWRENMEKDE YGTYBARLY ÇEŞME	61
Ruholla Şirazi (Eýran) NAMAZGA V EÝÝAMYNYŇ ADAM ŞEKILINE MEŇZEŞ TERRAKOT HEÝKELJIKLERI WE OLARYŇ GÖRNÜŞLERINIŇ WE ÝASALYŞ USULYNYŇ ÖWRENILIŞI	63
SURATLAR	213

CONTENTS

To participants of the International Scientific Conference
«Ancient Margiana is the new centre of the world civilization» 67

Victor Sarianidi

TURKMENISTAN AS A CENTRAL ASIAN CENTER
OF ANCIENT ORIENTAL CIVILIZATION 71

SCIENTIFIC REPORTS

Barbara Cherasetti (Italy)

THE BRONZE AGE IRRIGATION FACTOR IN THE
DEVELOPMENT OF URBANISM IN MIDDLE ASIA
AS SEEN FROM THE MURGHAB DELTA 88

Nadezhda Dubova (Russia)

GONUR POPULATION ACCORDING
THE ANTHROPOLOGICAL DATA 89

Henri-Paul Francfort (France)

THE OXUS CIVILIZATION (BMAC) AND THE LOCATION
OF MARKHASHI AROUND 2300-1800 BC 94

Gerard Fussman (France)

MARGUSH AND THE INDO-EUROPEANS 95

J.S. Kharakwal (India), **Toshiki Osada** (Japan)

BMAC, AHAR CULTURAL COMPLEX AND THE PROBLEM OF ARAYNS 104

Victoria Kryukova (Russia)

THE FEATURES OF THE COUNTRY OF MARGUSH AND
THE TRADITIONAL CULTURE OF THE PEOPLES OF CENTRAL ASIA 105

E.E.Kuzmina (Russia)

THE CULTURE OF MARGIANA AND BACTRIA IN THE FINAL
BRONZE AGE (EIA) AND IT'S ETHNICAL IDENTIFICATION 108

J. P. Mallory (Great Britain)

THE GONUR CEMETERY: A STATISTICAL

Mukhammed Mamedov (Turkmenistan)

APPROACH TO SOCIAL ORGANIZATION 109

ARCHITECTURE OF ANCIENT MARGIANA 110

Annamurad Orazov (Turkmenistan)

HEARTHES AND OVENS OF THE ADJIKUI OASIS 112

Asko Parpola (Finland)

THE ARYAN PROBLEM AND THE BMAC
(BACTRIA-MARGIANA ARCHAEOLOGICAL COMPLEX) 112

Gregory L. Possehl (USA) THE BACTRIA-MARGIANA ARCHAEOLOGICAL COMPLEX AND THE GREATER INDUS VALLEY	117
Colin Renfrew (Great Britain) MARGIANA AND BEYOND	129
B.N.Udeumuradov (Russia) SOME CONCEPTS OF MARGIANA STUDIES	131
Hemra Yusupov (Turkmenistan) HOLY WORSHIPS AND BELIEFS OF THE ANCIENT CATTLE-BREEDERS OF TURKMENISTAN	132

CONCISE MESSAGES

Hassan Akbari, Morteza Hessari (Iran) A PROOF OF CULTURAL RELATIONS IN THE THIRD MILLENNIUM B.C.	134
Annadursun Ataeva (Turkmenistan) TO THE HISTORY OF THE ANCIENT AGRICULTURE OF MARGIANA	134
Guncha Ataeva (Turkmenistan) SOME EVIDENCES OF PAGAN WORSHIPS AMONG THE TURKMENS	135
Oraz Babakov (Turkmenistan) ENEOLITHIC CRANIUM FOUNDED FROM ADJI KUI 1	136
Agamurad Baltaev (Turkmenistan) ETHNOGRAPHIC TRACES OF THE MOTHER GODDESS WORSHIP IN TURKMENISTAN	137
Frederique Brunet (France) TOWARDS THE 3RD MILLENNIUM IN CENTRAL ASIA: THE RELATIONS BETWEEN AKCHADARIA, MARGIANA AND SISTAN	137
Nurgozel Byashimova (Turkmenistan) CULTURAL RELATIONS OF ANCIENT MARGIANA WITH NEIGHBOURING COUNTRIES	138
Jepbarguly KHATAMOV, Jumamurat GURBANGELDIYEV (Turkmenistan) CIVILIZATIONS OF MARGIANA AND HARAPPA: HISTORICAL ROOTS OF CULTURAL RELATIONSHIPS	139
Fredrik T. Hiebert (USA) THE OASIS ENVIRONMENT OF BRONZE AGE GONUR DEPE	140
Manabu Koiso (Japan) INDUS AND INDUS RELATED SEALS FROM OUTSIDE THE INDUS TERRITORY	141
Gurbanjema Kuraeva (Turkmenistan) OBJECTIVES OF RESEARCHING THE ART CULTURE OF ANCIENT MARGIANA	141

Ejegul Muradova (Turkmenistan)	
THE BURIAL GROUND OF GONUR TEMENOS	142
Rouhollah Shirazi (Iran)	
TERRACOTTA ANTHROPOMORPHIC FIGURINES OF NAMAZGA	
V PERIOD: A TYPO-TECHNOLOGICAL APPROACH	143
Muradgeldy Soyegov (Turkmenistan)	
MODERN LANGUAGE AS A RELIABLE SOURCE	
TO STUDY THE ANCIENT OUTLOOK	144
PLATES	213

СОДЕРЖАНИЕ

Участникам Международной научной конференции "Маргиана — новый центр мировой цивилизации"	147
--	-----

В. И. САРИАНИДИ

ТУРКМЕНИСТАН — ЦЕНТРАЛЬНОАЗИАТСКИЙ ОЧАГ ДРЕВНЕВОСТОЧНОЙ ЦИВИЛИЗАЦИИ	151
--	-----

НАУЧНЫЕ ДОКЛАДЫ

Н.А.ДУБОВА (Россия) НАСЕЛЕНИЕ ГОНУРА ПО ДАННЫМ АНТРОПОЛОГИИ	169
В.Ю.КРЮКОВА (Россия) РЕАЛИИ СТРАНЫ МАРГУШ И ТРАДИЦИОННАЯ КУЛЬТУРА НАРОДОВ ЦЕНТРАЛЬНОЙ АЗИИ	174
Е.Е.КУЗЬМИНА (Россия) КУЛЬТУРА МАРГИАНЫ И БАКТРИИ ЭПОХИ ФИНАЛЬНОЙ БРОНЗЫ (РЖВ) И ЕЕ ЭТНИЧЕСКАЯ АТРИБУЦИЯ	178
ДЖЕЙМС МЕЛЛОРИ (Великобритания) НЕКРОПОЛЬ ГОНУРА: СТАТИСТИЧЕСКИЙ ПОДХОД К СОЦИАЛЬНОЙ ОРГАНИЗАЦИИ ДРЕВНЕГО ОБЩЕСТВА	180
М.А.МАМЕДОВ (Туркменистан) АРХИТЕКТУРА ДРЕВНЕЙ МАРГИАНЫ	182
АННАМУРАД ОРАЗОВ (Туркменистан) ОЧАГИ И ПЕЧИ АДЖИКУИНСКОГО ОАЗИСА	183
АСКО ПАРПОЛА (Финляндия) АРИЙСКАЯ ПРОБЛЕМА И БАКТРИЙСКО-МАРГИАНСКИЙ АРХЕОЛОГИЧЕСКИЙ КОМПЛЕКС	184
Г.Л. ПОССЕЛ (США) БАКТРИЙСКО-МАРГИАНСКИЙ АРХЕОЛОГИЧЕСКИЙ КОМПЛЕКС И ВЕЛИКАЯ ДОЛИНА ИНДА	189
КОЛИН РЕНФРЮ (США) МАРГИАНА И ОКРУЖАЮЩИЙ МИР	189
Б.Н.УДЕУМУРАДОВ (Россия) НЕКОТОРЫЕ КОНЦЕПЦИИ В ИССЛЕДОВАНИЯХ МАРГИАНЫ	191
АНРИ-ПОЛЬ ФРАНКФОРТ (Франция) ЦИВИЛИЗАЦИЯ БМАК И МЕСТОНАХОЖДЕНИЕ МАРХАШИ ОКОЛО 2300-1800 ГГ. ДО Н.Э.	193
ЖЕРАР ФУССМАН (Франция) ИНДОЕВРОПЕЙСКИЕ НАРОДЫ И МАРГИАНА	195
Д.С.ХАРАКВАЛ (Индия), Т. ОСАДА (Япония) БМАК, АХАРСКИЙ КУЛЬТУРНЫЙ КОМПЛЕКС И АРИЙСКАЯ ПРОБЛЕМА	196

БАРБАРА ЧЕРАЗЕТТИ (Италия) ИРРИГАЦИОННАЯ СИСТЕМА ЭПОХИ БРОНЗЫ И РОСТ УРБАНИЗАЦИИ В ДЕЛЬТЕ МУРГАБА	197
ХЕМРА ЮСУПОВ (Туркменистан) СВЯЩЕННЫЕ КУЛЬТЫ И ВЕРОВАНИЯ ДРЕВНИХ СКОТОВОДОВ ТУРКМЕНИСТАНА	198

КРАТКИЕ СООБЩЕНИЯ

Х. Акбари, М. Хессари (Иран) К ВОПРОСУ О КУЛЬТУРНЫХ СВЯЗЯХ В III ТЫСЯЧЕЛЕТИИ ДО Н.Э.	201
Аннадурсун Атаева (Туркменистан) К ИСТОРИИ ДРЕВНЕГО ЗЕМЛЕДЕЛИЯ МАРГИАНЫ	201
Гунча Атаева (Туркменистан) НЕКОТОРЫЕ СВИДЕТЕЛЬСТВА ЯЗЫЧЕСКИХ КУЛЬТОВ У ТУРКМЕН	202
Ораз Бабаков (Туркменистан) ЭНЕОЛИТИЧЕСКИЙ ЧЕРЕП ИЗ АДЖИ КУИ 1	203
Агамурад Балтаев (Туркменистан) ЭТНОГРАФИЧЕСКИЕ СЛЕДЫ КУЛЬТА БОГИНИ-МАТЕРИ В ТУРКМЕНИСТАНЕ	204
Фредерик Бруне (Франция) СВЯЗИ МЕЖДУ АКЧАДАРЬЕЙ, МАРГИАНОЙ И СЕИСТАНОМ В III ТЫСЯЧЕЛЕТИИ ДО Н.Э.	205
Нургозель Бяшимова (Туркменистан) КУЛЬТУРНЫЕ СВЯЗИ ДРЕВНЕЙ МАРГИАНЫ С СОСЕДНИМИ СТРАНАМИ	205
Манабу Коисо (Япония) ИНДСКИЕ И РОДСТВЕННЫЕ ИМ ПЕЧАТИ ИЗВНЕ	206
Курбанджемал Кураева (Туркменистан) ЗАДАЧИ ИЗУЧЕНИЯ ХУДОЖЕСТВЕННОЙ КУЛЬТУРЫ ДРЕВНЕЙ МАРГИАНЫ	207
Эджегуль Мурадова (Туркменистан) МОГИЛЬНИК "ТЕМЕНОСА" ГОНУРА	208
Муратгелди Соегов (Туркменистан) СОВРЕМЕННЫЙ ЯЗЫК КАК НАДЕЖНЫЙ ИСТОЧНИК ИЗУЧЕНИЯ ДРЕВНЕГО МИРОВОЗЗРЕНИЯ	209
Джепбаргулы Хатамов, Джумамурад Гурбангельдыев (Туркменистан) ЦИВИЛИЗАЦИИ МАРГИАНЫ И ХАРАППЫ: ИСТОРИЧЕСКИЕ КОРНИ КУЛЬТУРНЫХ СВЯЗЕЙ	210
Фредерик Хиберт (США) ОАЗИСНАЯ СРЕДА НА ПОСЕЛЕНИИ БРОНЗОВОГО ВЕКА ГОНУРДЕПЕ	211
Рухолла Ширази (Иран) АНТРОПОМОРФНАЯ ТЕРРАКОТА ПЕРИОДА НАМАЗГА V: ТИПО-ТЕХНОЛОГИЧЕСКИЙ ПОДХОД	212
ИЛЛЮСТРАЦИИ	213

Türkmenistanyň Medeniýet we teleradioýaýlymlar ministrligi
Türkmenistanyň milli medeniýet „Miras” merkezi
Türkmenistanyň Ministrler Kabinetiniň ýanyndaky Taryh instituty
Mary welaýatynyň häkimligi

GADYMY MARGIANA DÜNYÄ SIWILIZASIÝASYNYŇ TÄZE MERKEZIDIR

HALKARA YLMY MASLAHATYŇ NUTUKLARYNYŇ GYSGAÇA BEÝANY
2006-njy ýylyň Sanjar aýynyň 14-16-y

Redaksion topary:

A.Aşyrow (toparyň başlygy), W.Sarianidi (ylmy redaktor),
M.Mämmedow, R.Myradow, A.Halmyradow, J.Gurbangeldiýew

Halkara ylmy maslahatyň gysgaça beýanyňy Türkmenistanyň Medeniýet we teleradioýaýlymlar ministrligiň Taryhy we medeni ýadygärlikleri goramak, öwrenmek hem-de rejelemek baradaky milli müdirliginiň işgärleriniň işçi topary çapa taýýarlady.

Türkmenistanyň Metbugat merkezinde çap edildi.

Sargyt № 3079. Sany 300